



CALIFORNIA PROPOSITION 65

⚠ WARNING: *Operating, servicing, and maintaining a passenger vehicle or off-highway motor vehicle can expose you to chemicals including engine exhaust, carbon monoxide, phthalates, and lead, which are known to the State of California to cause cancer and birth defects or other reproductive harm. To minimize exposure, avoid breathing exhaust, do not idle the engine except as necessary, service your vehicle in a well-ventilated area and wear gloves or wash your hands frequently when servicing your vehicle. For more information go to www.P65Warnings.ca.gov/passenger-vehicle.*

⚠ WARNING: *Some vehicle parts, such as lithium batteries, may contain perchlorate material. The following advisory is provided: "Perchlorate Material - special handling may apply. For additional information, refer to www.dtsc.ca.gov/hazardouswaste/perchlorate.*

⚠ WARNING: *Battery posts, terminals and related accessories contain lead and lead-based compounds, wash hands after handling.*



IL SOGNO DI BATTISTA

IL SOGNO DI BATTISTA

Battista “Pinin” Farina. The Picasso of the automobile world. Having designed some of the world’s finest automobiles, he always had one dream: to one day see a range of solely-Pininfarina branded cars on the road, a move which would see revered the Pininfarina badge adorn the front of its design masterpieces, rather than the side. This dream remained unrealised. Until now.

The story of Automobili Pininfarina is a story of relentless pursuit of more, the constant research of what comes next. In this visionary story, where uncompromised beauty meets state of the art technology and engineering, the ultimate aim is not to evolve, but to transform the concept of luxury automotive, in true spirit of the Pininfarina name.



*“La Battista è un sogno che si avvera.”
– Paolo Pininfarina*

CRAFTED IN CAMBIANO

The Home of Automobili Pininfarina

The beauty of a place with historic automotive significance is in the stories that it tells. A story of people pushing the boundaries of the known, of legendary moments that led to the creation of icons. You sense how multiple generations have been working on finding the answer to that one question: “where do we go next?” Cambiano is such a place. A place where for many decades that search for design excellence and

technological innovation has been the key to the creation of visionary automobiles.

Walking through the ateliers shows how the combination of Italian artistry, world-leading design expertise and advanced engineering goes hand in hand in the process of shaping that next step in the history of the automobile.

With the creation of the Battista pure electric hyper GT in Cambiano, Automobili Pininfarina is realising the dream of Battista “Pinin” Farina. His visionary spirit is still with us today, in our mission to create a new, sustainable luxury in automotive with an eye on the future.





PURA DESIGN PHILOSOPHY

The Tradition of the New

A tradition of leading innovation. To follow is simply not an option. When starting a design process, we like our playbook empty: experience is our strength, the force that allows us to take the risk of being innovative on our quest for design purity. It is a bond between essence and form. One must reflect the other, in the most clear and exquisite way. Over-complications are not allowed. Pure lines, pure materials, pure performance. Visionary Italian design is our essence. Sustainability and luxury is our future. This is PURA design. Purity or nothing.

*"Above all, it must be beautiful." –
Battista Pininfarina*

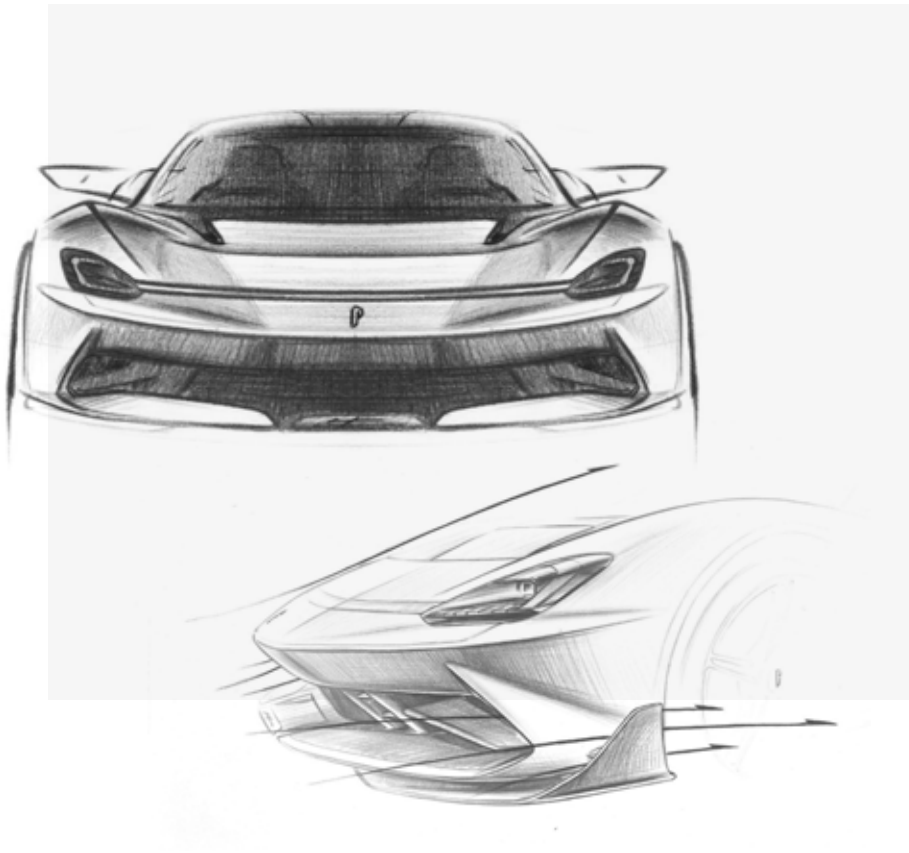

MATERIALS AND FINISH

Innovation. Sustainability.

Craftsmanship.

PURA design was at the core of all parts of the design process of Battista, from its voluptuous design to the development of materials and selection of colour and finishes. As the rules of luxury are being rewritten, our team is on a mission to create beautiful objects of desire without compromise. As the world's first luxury electric car brand, it is our vision to create a future where sumptuous and sustainable are one. Our journey begins, as ever, in design.

La Tradizione del Nuovo

We are fearless innovators at heart. We are incredibly proud of our heritage, and yet we embrace the future with our curious minds. Traditional materials re-interpreted with the latest EV technologies will be at the core of our strategy.

Un Lusso Sostenibile

We believe that luxury can and must be sustainable, and it shouldn't compromise on quality or beauty. We challenge ourselves and our partners to reconsider and re-invent the way we look at materials and processes, embarking on a journey toward a sustainable future.

Eccezionale Maestria

We are committed to deliver the highest possible quality and we strive to achieve perfection in every single detail. We combine incredible craftsmanship with exquisite materials to create a unique experience for our clients.





SUSTAINABILITY

A new take on luxury

Artisan Leather

Authentic Italian Luxury. We select exceptional quality leathers that we source through a network of partners, each committed to sustainable material creation. Our specialists carefully use olive tree leaves in the tanning process, removing the need for chemical treatment. The result is an environmentally friendly, yet beautiful and highly durable leather interior in your Battista.

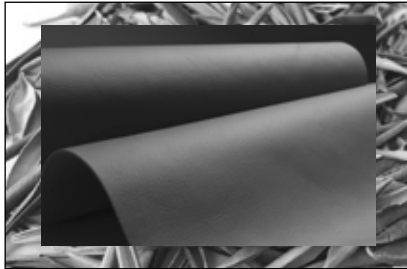

Econyl floormats

Quality is defined by the refinement of execution and extreme attention to details. The Battista floor protection mats have been created with sustainability in mind. The material used is Econyl, an innovative yet sustainable material, created by recycling discarded fishing nets recovered from the oceans. A proof that luxury and sustainability are not in conflict.

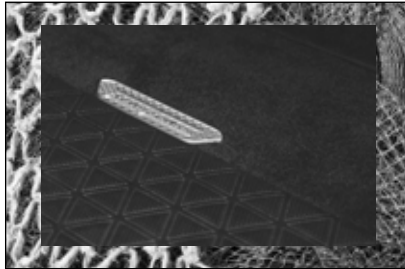

Carbonfibre

Carbon is the most important material in the creation of Battista. Carbonfibre requires such a level of skills and craftsmanship, it can be compared to haute couture. This inspired our approach to designing our Signature Twill with our signature 'Iconica Blue' coloured thread, a unique and exclusive weave pattern that brings to mind a beautifully tailored suit.



COACH-BUILDING

Unique one-off cars for our clients

At Automobili Pininfarina, we make dream cars real. Honouring Pininfarina's legendary coachbuilding heritage of iconic one-offs, we hand-craft bespoke automobiles that cater to the exacting tastes of our discerning clients. Each vehicle seamlessly merges Italian design and craftsmanship with cutting-edge technology, creating masterpieces that reflect our owners' individuality.

Just like our clients, no two cars are alike. Our commitment to 'Dream Cars, Made Real' is exemplified by the world's first pure-electric, open-top hyper Barchetta—the breathtaking B95 by Automobili Pininfarina.

This coach-built two-seater delivers the performance of Battista and yet creates an all-

new visceral driving experience tailored to our clients.

The one-off Targamerica, the first coach-built car delivered to a client by Automobili Pininfarina, further underscores this promise. Every dream machine is meticulously hand-crafted in Cambiano, Italy.

Battista, B95 and the one-off Targamerica are assembled to the highest quality by our expert craftsmen, whose skills have been honed through years of crafting limited series and unique cars for the world's most esteemed marques. This artisanal approach, the automotive equivalent of haute couture, ensures that every vehicle we deliver is a one-of-kind car to satisfy our client's dream.

*"We collaborate to deliver purity of design, performance and elegance"—
Dave Amantea, Chief Design Officer*







FOR VEHICLES IN NORTH AMERICA

CONTACTING AUTOMOBILI PININFARINA

To find out more about the Pininfarina Battista, go to automobili-pininfarina.com. If you have questions or concerns about your vehicle and you are located in North America, call 1-833-975-0915 and/or email customer-service@automobili-pininfarina.com.

REPORTING SAFETY DEFECTS

NHTSA's Toll-free Auto Safety Hotline

If you believe that your vehicle has a defect which could cause a crash or could cause injury or death, you should immediately inform Automobili Pininfarina to get immediate assistance. You can also contact the National Highway Traffic Safety Administration (NHTSA) to report a defect.

If NHTSA receives similar complaints, it may open an investigation, and if it finds that a safety defect exists in a group of vehicles, it may order a recall and remedy campaign.

However, NHTSA cannot become involved in individual problems between you, your Service Partner, or Automobili Pininfarina.

To contact NHTSA, you may call the Vehicle Safety Hotline toll-free at 1-888-327-4236 (TTY: 1-800-424-9153); go to <http://www.safercar.gov>; or write to: Administrator, NHTSA, 400 Seventh Street, SW., Washington, DC 20590.

You can also obtain other information about motor vehicle safety from <http://www.safercar.gov>.



Reporting safety defects in Canada

If you believe your vehicle has a defect that could cause a crash or could cause injury or death, you should immediately inform Transport Canada in addition to notifying Automobili Pininfarina.

Transport Canada

ASFAD 330 Sparks Street Ottawa, ON K1A 0N5

Telephone: 819-994-3328 (Ottawa- Gatineau area or internationally) Toll free: 1-800-333-0510 (in Canada)

Online: <http://www.tc.gc.ca/recalls>

PRESENTATION

We have prepared this booklet to help you take full advantage of the technical qualities of this car; inside it you will find information, features, warnings, operations, and important tips for maintenance and driving safety.

It is recommended to read it in all its parts before setting out for the first time to drive, in order to familiarize yourself with the controls and at the same time to begin to better understand the behavior of the car.

The data contained in this publication is intended for the correct and safe use of the car.

The car could be equipped with optional contents and dedicated equipment. Therefore, it is necessary to consider only the information relating to the configuration of the car purchased by you.

Automobili Pininfarina is

constantly engaged in the process of development of the vehicles produced, thus reserving the right to make changes to the model described for technical reasons.

Within this Booklet you will be provided with the Warranty information in which you will find the description of the Assistance Services that Automobili Pininfarina offers to its customers and the detail of the terms and conditions for maintaining it.

The Automobili Pininfarina Authorized Service Partners will provide you with the assistance necessary to satisfy your request.

IMPORTANT *This booklet contains the main information to keep in the car for a quick consultation, for more information please view the digital version available in the infotainment system, mobile phone app or the complete version available at the following address:*



Vehicle's Screen designs are subject to change due to product improvements.

IMPORTANT SAFETY INFORMATION!



It is important to adhere to the following driving rules to help ensure a safe and comfortable journey for you and your passengers:

- Battista is a hyper GT capable of extreme performance while also capable of delivering an easy to drive experience that can be enjoyed on a public road thanks to all the built-in safety systems. It is recommended that the driver attends a performance driving course to familiarize themselves with its capabilities.
- Please do not explore vehicle's capabilities on public roads, but in controlled environment.
- Always observe the speed limits, road signs indicated and local rules of the road.
- Always pay close attention while driving, avoiding behaviors that could distract you.

- Always wear seat belts.
- Provide information for the correct use of the safety functions to all occupants of the vehicle.
- If in doubt about the correct use of the car, consult this Booklet, the on-line complete booklet at www.automobili-pinininfarina.com or contact an Official Automobili Pininfarina Service Partner.

WARNINGS AND PRECAUTIONS

The WARNINGS in this booklet are divided into three types:

-  Personal safety.
-  Vehicle safety.
-  Environmental protection

There are also PRECAUTIONS to be followed carefully to avoid inappropriate use of the vehicle components which could cause accidents.

It is advisable to scrupulously observe all the WARNING and CAUTION recommendations reported in this Booklet.

SYMBOLS



When you find this symbol before a text or a paragraph, it refers to contents specific to US markets.



When you will find this symbol before a text or a paragraph, it refers to contents specific for Canada markets.

ELECTRIC VEHICLE OVERVIEW

The BATTISTA is a high-voltage, purely electric vehicle.

Some of the vehicle's systems operate differently and have different operating characteristics than vehicles equipped with an internal combustion engine.

It is important to carefully review the entire Owner's Manual for this reason.

The BATTISTA uses electric energy stored in the lithium ion (Li-ion) battery.

Prior to being driven, the vehicle high voltage battery MUST be charged with electricity, using one of the many compatible chargers (refer to "Charging" Chapter for details).

All Battista systems derive their energy from the High Voltage Battery. A 12V and 48V Li-Ion battery is fitted in the car and recharged via DC-DC converter from the High Voltage Battery

automatically. These 2 lower voltage batteries are used to power systems that run at lower voltage, such as lights, seats, pumps.

As the vehicle operates, the high voltage battery will gradually discharge. As it does so, some limits may be applied to the powertrains, this is considered normal operation.

Additionally, climatic conditions such as extreme heat or extreme cold may lead the BATTISTA to automatically restrict some of its functionalities in order to preserve its components from undue damage.

BATTISTA can be charged on compatible AC (alternating current) and DC (direct current) chargers (refer to "Charging" chapter for further information). Due to the current diversity of the chargers' infrastructure, it is recommended to the Driver to check for an alternative compatible charging source near their destination, prior to

departure (refer to "Navigation" section in "Instrument Panel" Chapter to find the compatible charging point).

This vehicle is a Zero Emissions Vehicle during usage because it does not emit exhaust gases, such as carbon dioxide and nitrogen oxide.

WARNING

Your vehicle contains a sealed Li-ion high voltage battery (800v), a Li-ion 12V and 48V low voltage battery (refer to "Electric vehicle components" in "Charging" chapter for the position of batteries). Both high voltage and low voltage batteries are based on lithium-ion chemistry, offering high energy density in a lightweight package.

If a Li-ion battery is disposed of improperly, there is a risk of severe burns and electrical shock that may result in serious injury or death and there is also a risk of environmental damage.

⚠ CAUTION

To prevent damage to the Li-ion batteries:

- Do not expose the vehicle to extreme ambient temperatures for extended periods.
- Do not store the vehicle in temperatures below -20°C or above $+65^{\circ}\text{C}$ for extended periods of time.
- If the state of charge is below 15%, do not leave the vehicle unplugged for longer than 14 days.
- If the state of charge is below 15%, it is strongly recommended to plug the vehicle in order to charge the battery.
- If the vehicle is not used for a longer period, make sure to maintain at least minimum charge (see section "Vehicle Inactivity" under "Maintenance" chapter).

⚠ WARNING: Do not attempt to operate the vehicle with temperatures below -20°C .

⚠ WARNING: Do not attempt to open or dismantle any of the batteries.

⚠ WARNING: In case of visual damage to any of the batteries, immediately contact an Automobili Pininfarina Service Partner for a safety assessment.

⚠ WARNING: Do not attach any 12V battery chargers/tenders that are not certified or authorized by Automobili Pininfarina. Use of incorrect charger on a Lithium-Ion battery can lead to damage of the battery and fire hazards. Your vehicle is capable of maintaining its 12V and 48V batteries and the use of a low-voltage battery charger should not be necessary. For any further information contact your Automobili Pininfarina Service Partner.

Summary

Il sogno di Battista	4
Crafted in Cambiano.....	5
PURA Design philosophy.....	6
Materials and Finish	7
Sustainability	8
Coach-building.....	9
Presentation.....	13
Important safety information!.....	14
Warnings and precautions	14
Symbols.....	14
Electric vehicle overview	15

ILLUSTRATED TABLE OF

CONTEXT	19
Front view	19
Rear view	20
Dashboard	21

SAFETY

23	
Seat belts.....	23
Air bags.....	27
Child passengers.....	33
Event data recorders.....	35
Electric vehicle safe-guard system	36
Tire pressure monitoring system.....	37
Acoustic Vehicle Alerting System (AVAS).....	39

INSTRUMENT PANEL

41	
Displays	42
Left display	43
Central display	44
Right display	45
General settings.....	45
Media sources	47
Navigation	48
Audio.....	50
Media Joystick.....	50
Connecting to wi-fi.....	51
Over The Air Updates (OTA).....	51
Phone.....	52
Climate controls.....	55
Warning lights and messages.....	57
Instrument panel notification	62
Acoustic notifications.....	62

CONTROLS AND SETTINGS.....

65	
The keys.....	65
Silent alarm.....	69
Doors.....	70
Removable soft top.....	74
Bonnet	77
Seats.....	78
Steering wheel.....	82
Controls on dashboard.....	83
Air diffuser.....	84
Rear view mirror	85
Door mirrors.....	86
External lights	87
Reading lights.....	91

Ambient lighting	92
Windscreen wiper.....	93
Electric windows	94
Luggage compartment liftgate	95
Interior fittings.....	96

STARTING AND DRIVING.....

101	
General information.....	101
Gear selector knob	102
Starting the car and driving.....	102
Parking the vehicle.....	103
Gear selection.....	104
Drive mode knob.....	106
Drive mode settings.....	106
Limp mode.....	114
Tow mode	114
Valet mode.....	115
Driving safety system	116
Creep mode.....	119
Automatic vehicle hold (AVH).....	119
Rear spoiler	120
Brakes.....	121
G-force meter / performance overview / trip performance.....	123
Cruise control	124
Lift function	126
Park sensors system	127
View cameras	129
Getting maximum range.....	131
Tire selection	132

CHARGING..... 135

- Electric vehicle components136
- Battery care / information138
- Charging instruction139

IN AN EMERGENCY 145

- Hazard warning lights.....145
- Lifting the vehicle.....145
- 12V power supply.....146
- Tool kit.....147
- Charging socket unlock tool.....148
- Flat or puncture of tire149

MAINTENANCE 153

- Scheduled servicing153
- Basic servicing procedures.....157
- Rims and tires159
- Car inactivity (long term storage)164
- Preserving the bodywork.....165
- Vehicle transportation166

TECHNICAL DATA 167

- Identification data.....167
- Gearboxes170
- Brakes.....170
- Suspension.....170
- Battery171
- Steering.....171
- Automobili pininfarina approved tires172
- Dimensions.....174

- Weights174
- Fluids and lubricants175
- Conformity declaration for frequency.....175

NEW VEHICLE LIMITED WARRANTY..... 179

- General warranty provisions179
- Warranty coverage.....181
- Exclusions and limitations184
- Obtaining warranty service188
- Consumer law and national regulations189
- Warranty enforcement laws and dispute resolution190
- National center for dispute settlement ("NCDS") P.O. Box 526191

ROADSIDE ASSISTANCE 195

ILLUSTRATED TABLE OF CONTEXT

FRONT VIEW

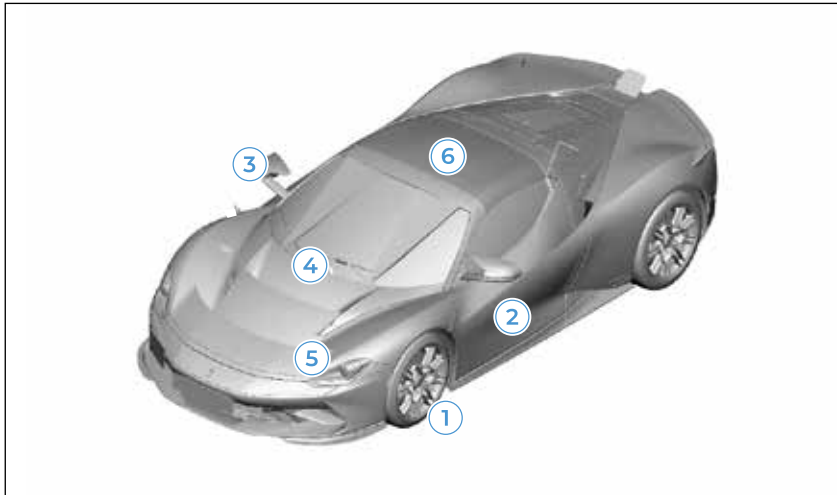

1 - WHEELS

Rims and tires	161
Automobili pininfarina approved tires	174
Maintenance	155
Flat or puncture of tire	151
Tire repair kit	152
Tire pressure monitoring system	37

2 - DOORS

Using the key	67
Doors	72
Driver side door emergency opening	69
Silent alarm	71

3 - DOOR MIRRORS 88

4 - WINDSCREEN WIPER 95

Topping up windshield washer fluid	161
---	-----

5 - HEADLIGHTS

External lights	89
-----------------------	----

6 - REMOVABLE SOFT TOP 76

Washing/cleaning the soft top	78
--	----

REAR VIEW

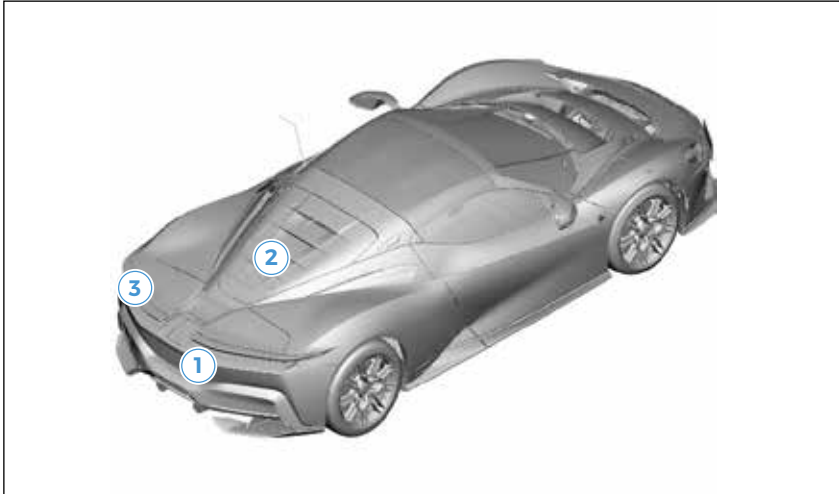

1 - CHARGE PORT

Charging instruction	141
Starting to charge	141
Stopping Charge and Removing Cable	142
Charge port indication (E-Heart)	143
Battery care / information	140

2 - TRUNK TAILGATE

Luggage compartment liftgate	97
---------------------------------------	----

3 - REAR LIGHTS

External lights	89
-----------------------	----

DASHBOARD

1 - LEFT DISPLAY	43
Warning lights and messages	59
2 - CENTRAL DISPLAY	45
3 - RIGHT DISPLAY	46
General settings	46
Navigation	49
Media sources	48
Audio	51
Phone	53
4 - STEERING WHEEL	84
Adjustment	84
Controls on steering wheel	85
Front airbags	28
5 - AIR DIFFUSER	86
Climate controls	57
6 - CONTROLS ON DASHBOARD	85
Electric windows	96
7 - PASSENGER SIDE FRONT AIRBAG	28
8 - GLOVE BOX	100
9 - FULL (LCD) LIQUID-CRYSTAL DISPLAY INTERIOR MIRROR	87
10 - SEATS	80
Seat belts	23

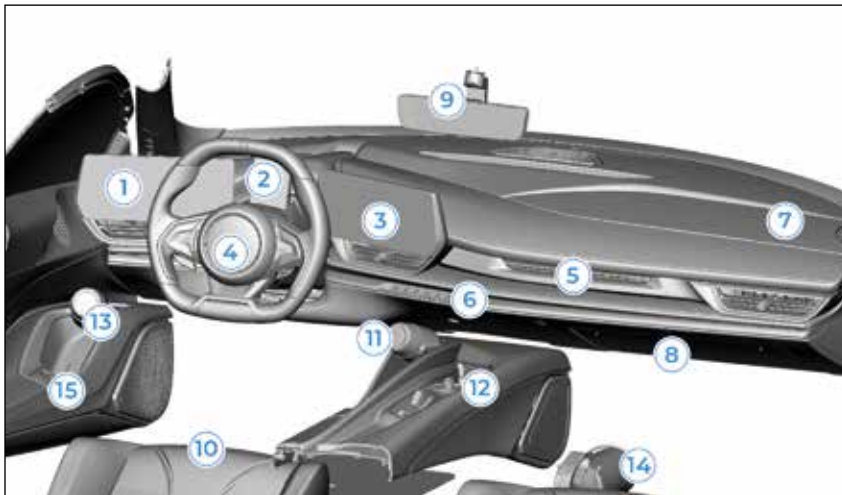

11 - GEAR SELECTOR KNOB	104
12 - MEDIA JOYSTICK	51
13 - DRIVE MODE KNOB	108
14 - FIRE EXTINGUISHER	100
15 - DOORS	72



SEAT BELTS

⚠ WARNING: Always keep your seatback upright and the lap belt low across the hips with no slack.

⚠ WARNING: All occupants must always be properly restrained by a seatbelt.

⚠ WARNING: Never hold a child on your lap when your vehicle is moving. Personal injury or death could occur in the event of a collision.

⚠ WARNING: In a rollover crash, an unbelted occupant is more likely to be severely injured than a person wearing a seatbelt.

⚠ WARNING: Both seating positions in your vehicle have a specific seatbelt assembly made up of one buckle and one tongue designed to be used as a pair. Wear the shoulder belt on the outside

shoulder only. Never wear a shoulder belt under your arm. Never use a single seatbelt assembly for more than one person.

⚠ WARNING: All occupants of your vehicle, including the driver, should always properly wear their seatbelts, even when an airbag supplemental restraint system is provided. Failure to properly wear your seatbelt could seriously increase the risk of injury or death.

⚠ WARNING: Avoid contaminating a seat belt's components with any liquids, dirt, debris, or cleaning products. If a seat belt fails to latch into the buckle, it should be replaced immediately.

⚠ WARNING: Hot seatbelts or seats may burn those with sensitive skin if the vehicle is left in direct sunlight. Check the seat and buckles before you utilize them.

⚠ WARNING: Do not make modifications that interfere or change the operation of a seat belt, or that cause a seat belt to become inoperable.

⚠ WARNING: If your vehicle is involved in a low-medium severity collision, have the seatbelts and associated components inspected as soon as possible.

Both seat belts have three anchor points and a retractor.

The retractor mechanism operates locking the belt in the event of sharp braking or strong deceleration and due to an impact. This allows the belt strap to slide freely and to adapt to the body of the occupant. In the event of an accident, the belt will lock reducing the risk of impact inside the passenger compartment and of being projected outside the vehicle.

The passenger seat belt is fitted with the KISI system, which improves safety when children are travelling in special child seats. The system is activated by pulling out the belt to its full length: once the child seat is securely fastened, the belt can no longer be pulled out and hence the belt/child seat system is exceptionally secure. When the belt is released and fully retracted, the system deactivates and resumes its normal operation. To fasten the seat belts, hold the tongue 1 and insert it into the buckle 2, until it clicks into place. On removal of the belt, if it jams, let it rewind for a short stretch, then pull it out again without jerking. To unfasten the seat belts, press button 3 and guide the seat belt with your hand while it is rewinding, to prevent it from twisting.

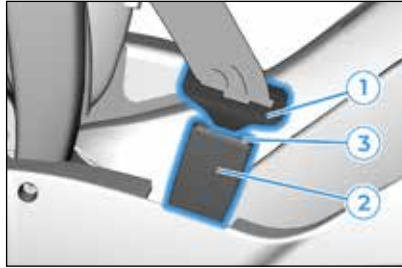

Seat belt reminder

The seat belt reminder system warns driver and passenger if their seat belt is not fastened. The system warns unfastened seat belts with visual warnings



(warning lights on the instrument panel and icons on the display) and an acoustic warning.

Pretensioners

⚠ WARNING: *If seat belt pretensioners are activated, they must be replaced. Seat belt pretensioners, seatbelts, airbags, and associated components*

must be checked and, if necessary, replaced by an authorized service provider after a collision.

The car is equipped with front seat belt pretensioners, which draw back the seat belts by several centimeters in the event of a strong frontal impact. This allows the seat belts to adhere to the occupants' bodies before the retention action begins.

It is evident that the pretensioners have been activated when the belt withdraws toward the retractor. The pretensioner does not require any maintenance or lubrication: any changes to its original conditions will invalidate its efficiency.

IMPORTANT *To obtain the highest degree of protection from the action of the pretensioner, wear the seat belt tight to the torso and pelvis.*

General instructions for wearing seat belts

The seat belt must not be twisted. The upper part must pass over the shoulder and cross the chest diagonally. The lower part must adhere to the pelvis, not to the abdomen of the occupant.

Never use devices (clips, clamps, etc.) that hold the seat belt away from your body.

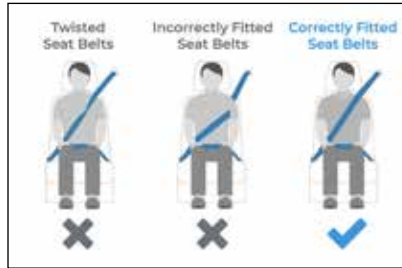

Each seat belt must be used by only one person. Never travel with a child sitting on the passenger's lap and a single belt to protect them both. In general, do not place any objects between the person and the belt.

i *NOTE* Due to the extreme performance capabilities of the Battista, it is recommended that pregnant people do not ride in the vehicle.

If a pregnant individual is on-board the Battista, a seatbelt should be worn to ensure the safety of the mother and unborn child. Do not wear the shoulder or lap sections of the seatbelt over the abdominal area. The lap section of the seatbelt should be as low as possible across the hips, and not the waist. The shoulder portion of the seatbelt should be positioned between the breasts and to the side of the abdomen. Ensure that the seatbelt is not twisted or slack. Please consult your doctor for additional medical guidance.

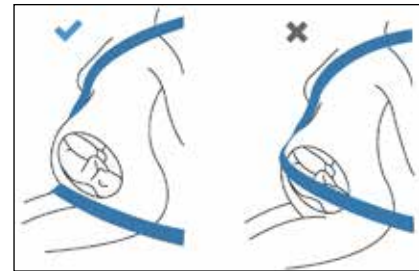



Seat belts maintenance

For keeping the seat belts in efficient conditions, carefully observe the following warnings:

- Check seat belt operation as follows: attach the seat belt and pull it hard.
- Always use the seat belt well stretched and never twisted; make sure that it is free to run without obstructions.
- Prevent the retractors from getting wet: their correct operation is only guaranteed if water does not get inside.
- Replace the seat belt when it shows wear or cuts.
- If the seat belt webbing retracts slowly, it may be required to clean the webbing using damp cloth with mild soap and allow it to dry.

 *Removing or otherwise tampering with pretensioner and seat belt components is strictly prohibited. Any intervention on these components must be performed by qualified and authorized technicians.*

 **WARNING:** *For maximum safety, keep the backrest upright, lean back into it and make sure the seat belt fits closely across your chest and pelvis. Always fasten the seat belts! Travelling without wearing seat belts will increase the risk of serious injury and even death in the event of an accident.*

 **WARNING:** *Seat belt pretensioners, seatbelts, airbags, and associated components must be checked and, if necessary, replaced by an authorized service provider if it has been subjected to high levels of stress, for example after a collision.*

 **WARNING:** *Each safety belt must be replaced by an approved safety belt for the seating position considered in the vehicle, those seating positions must be fitted with an appropriate safety belt equipped with a load limiter.*

AIR BAGS

Airbags are supplemental restraint devices that inflate when their sensors detect an impact that exceeds deployment thresholds. The inflated airbag, together with the seat belts, restrain the occupants to reduce the risk of injury.

The deployment thresholds are designed to calculate the severity of a collision in time to inflate the airbags to help protect the vehicle's occupants. Airbags inflate in milliseconds with considerable force accompanied by a loud noise. The vehicle is equipped with:

- 1 Front Driver airbag ;
- 2 Front Passenger airbag ;
- 3 Driver and passenger front side bags for head protection.

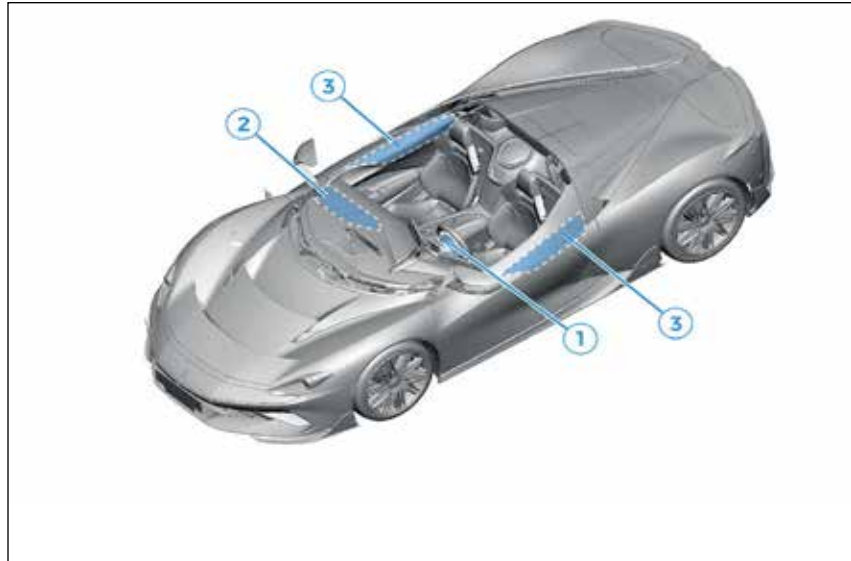

Front airbags

The front (driver and passenger) airbags protect the front seat occupants in the event of frontal impacts, when sensors detect an impact that exceeds deployment thresholds.

Therefore, non-activation of airbags in other types of collisions (side impacts, rear shunts, roll-overs, etc.) does not indicate a system malfunction.

⚠ WARNING: *All occupants, including the driver, should always properly utilize seat belts, even when an airbag supplemental restraint system is provided. Failure to properly wear your seatbelt could seriously increase the risk of injury or death in the event of a collision.*

Front airbag driver's side

This consists of an instantly inflating bag contained in a special compartment in the center of the steering wheel.

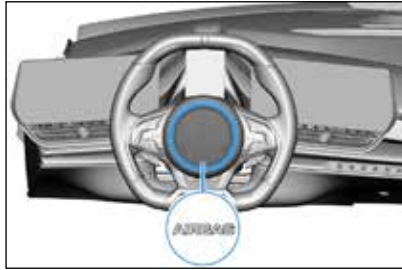

Passenger side front airbag

This consists of an instantly inflating bag contained in a special recess in the dashboard. This bag has a larger volume than that of the drivers.

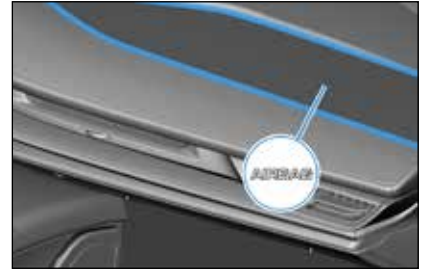

⚠ WARNING: *NEVER use a rearward facing child restraint on a seat protected by an ACTIVE AIRBAG in front of it, DEATH or SERIOUS INJURY to the CHILD can occur. ALWAYS comply with the instructions applied to the driver/passenger side sun visor as well as the label that is also placed on the roof headliner.*



EU airbag label



US airbag label



Canada airbag label

Passenger side airbags deactivating/activating

i NOTE The occupant classification system (OCS) meets the regulatory requirement of FMVSS208 and automatically detects when inflating the passenger front airbag (PAB) would be unnecessary or potentially harmful to the passenger.

⚠ WARNING: Seating an infant in a rear facing child safety seat on a seat equipped with an operational airbag can cause severe injury or death.

Object Classification	OCS Passenger Airbag status	Indicator status	Notes
Empty	OFF	PASSENGER AIRBAG OFF	
Object	OFF or ON	PASSENGER AIRBAG OFF or PASSENGER AIRBAG ON	Depends on volume, positioning, and weight. Weight threshold for PAB activation is 70.5lbs (32kg)
Rear facing child seat designed for children up to a year old	OFF	PASSENGER AIRBAG OFF	20lbs (9kg) or less
Forward facing child seat	OFF	PASSENGER AIRBAG OFF	35lbs (16kg) or less
Child in a booster seat	OFF or ON	PASSENGER AIRBAG OFF or PASSENGER AIRBAG ON	20-70.5lbs (9-32kg) *
Large child	OFF or ON	PASSENGER AIRBAG OFF or PASSENGER AIRBAG ON	20-70.5lbs (9-32kg)
5th percentile female or larger (by weight)	ON	PASSENGER AIRBAG ON	Over approximately 100 lbs. (45kg) **

* If the passenger airbag status indicator does not match the situation, do not use the seat.

** Not crossing legs over the top, which can harm passenger in an event of airbag deployment and potentially cause the OCS to not read the weight correctly.

⚠ WARNING: *This is a high-performance vehicle that can achieve very high rates of acceleration and speed. Always make sure that all those on board the car are properly seated and are wearing their seat belts correctly. Inappropriate sitting postures (for example crossing one leg on top of the other) can increase the risks of injury in case of an accident. Additionally, it may cause the occupant classification system (OCS) to improperly classify the passenger in the seat.*

⚠ WARNING: *The occupancy classification system is designed to disable the passenger frontal airbag under these conditions:*

- The passenger seat is unoccupied.
- The sensing system determines a child is present in a child restraint.
- A passenger takes their weight off the passenger seat.

- If there is a problem with the air bag system or the passenger sensing system.

An illuminated tell-tale will be shown on the display if the passenger side airbag is disabled.



To make sure the sensing system can accurately detect occupancy status, eliminate the following:

- Items sitting on the seat.
- Items stored under the seat.
- Items stuck between the seat back and seat cushion.
- Items placed behind the seat.
- Aftermarket items such as covers attached to, or sitting on or between, the seat and the passenger.

The conditions above can interfere with the proper operation of the occupancy sensor. Contact an authorized service provider to have the airbag system checked if the sensing system is inaccurately detecting occupancy status.

⚠ WARNING: *If the passenger airbag indicator light is not turning on or off as expected, don't drive, and contact an authorized service provider immediately.*

Side Bags

These consist of one air bag mounted into each door within the door panel that protects the occupants' head area in the event of a side impact of medium/high severity.

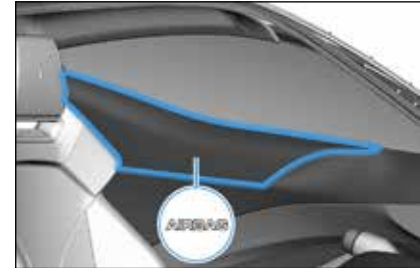

⚠ WARNING: Do not apply stickers or other objects on the steering wheel, on the dashboard in the passenger side airbag area, on side upholstery on the roof or on door interior trim. Never put objects (e.g., mobile phones) on the passenger side of the dashboard since they could interfere with correct inflation of the passenger airbag and also cause serious injury to the passengers.

⚠ WARNING: Do not allow passengers to obstruct the operation of an airbag by placing their feet, legs, knees, or any other part of the body on or near an airbag module. Occupants should not place any part of their body over the airbag modules, as an inflating airbag can cause injuries.

⚠ WARNING: Always drive with your hands on the rim of the steering wheel so that the airbag can inflate freely if required. Do not drive with your body bent forward. Keep your back straight against the backrest.

⚠ WARNING: Never lean your head, arms, or elbows out of the window.

⚠ WARNING: The airbag indicator light  briefly illuminates as the vehicle turns on as a function check, if the warning

light  illuminates in any other conditions, a fault may have occurred in the restraint systems. Contact a Service Partner immediately to have the system checked. If the airbag indicator light remains illuminated the airbag will not function, contact an authorized service provider immediately to repair the system.

⚠ WARNING: Do not travel carrying objects in your lap, in front of your chest or between your lips (pipe, pencils, etc.): They could cause severe injury if the airbag is deployed.

⚠ WARNING: Airbags inflate with large amounts of force. To minimize the potential of air-bag-related injuries, ensure that all occupants are wearing seat belts properly and are correctly seated. The National Highway Traffic Safety Administration (NHTSA) recommends a minimum distance of 10" (25 cm) between an occupant's breastbone and the airbag cover.

⚠ WARNING: Airbag system components can be hot after inflation. To reduce the risk of injury, do not touch them after inflation.

⚠ WARNING: Modifications to the vehicle for persons with disabilities: Contact Automobili Pininfarina before making modifications to the vehicle that may affect the airbag systems.

CHILD PASSENGERS

⚠️ WARNING: *Automobili Pininfarina does not recommend transporting children or infants in the Pininfarina Battista, but if you choose to do so, follow the guidelines laid out below:*

⚠️ WARNING: *If seating a child in the front passenger seat is legally permissible in your market region, it is the driver's responsibility to ensure that the passenger front airbag is OFF. **Never seat a child in a rear facing safety seat in the front passenger seat with an active airbag. DEATH or SERIOUS INJURY to the child can occur.***

⚠️ WARNING: *If you decide to transport children or infants in the Pininfarina Battista, please make sure to use a proper child restraint seat:*

- Any child under 4 ft 11 in (1.5m) tall or younger than 12 years old should be secured in an appropriate restraint according to their weight.

- Refer to current national and local laws for specific requirements.
- Contact an authorized Automobili Pininfarina representative for more information.

⚠️ WARNING: *Never leave a child or pet unattended in the vehicle. Failure to follow this instruction could result in personal injury or death.*

EUROPE The Pininfarina Battista meets the requirements of type approval for small series manufactured vehicles in Europe. This small series type approval exempts the Pininfarina Battista from certain requirements such as ISOFIX systems for the connection of child restraint systems. The Pininfarina Battista is not equipped with an ISOFIX system, please contact your authorized service provider for more information.

The passenger seat belt is fitted with the KISI system, which improves safety when children are travelling in special child seats.

The system is activated by pulling out the belt to its full length.

Pass the seat belt through the child restraint as described by the child restraint manufacturer and engage the belt latch in the buckle.

Adjust the belt so that the lower section is tight against the restraint and allow the upper section to retract. When the seat belt has retracted as far as possible pull on the upper section to check that the seat belt has locked.

Once the child seat is securely fastened, the belt can no longer be pulled out and hence the belt/child seat system is exceptionally secure.

When the belt is released and fully retracted, the system deactivates and resumes its normal operation.

Tether strap anchorages

An upper tether anchorage is provided only behind the passenger's seat.

To expose the fixing hook, remove the cover 1.

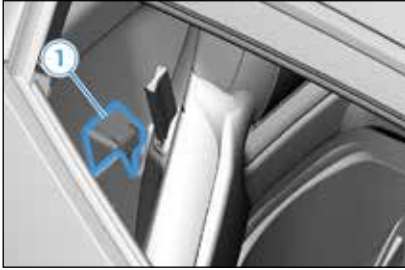

Many forward-facing child restraints include a tether strap which extends from the back of the child restraint and hooks to anchorage point 2.

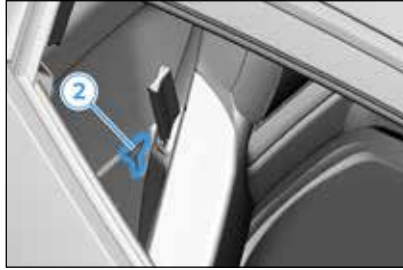

Install the child seat and pass the upper tether strap over the top of the seat back, under the head rest, secure it to the anchorage and tighten fully.

There are dual strap tether style seats available for purchase in the aftermarket, in this case pass both the strap under the head rest and secure them to the anchorage point.

NOTE Contact the manufacturer of your child restraint for information about ordering a tether strap or obtaining a longer tether strap.

WARNING: Tighten upper tether straps according to the instructions provided by the manufacturer of the child safety seat.

WARNING: Once the child restraint is installed, test the security of the installation before seating a child. If the child restraint is not anchored properly, the risk of a child being injured in a crash greatly increases.

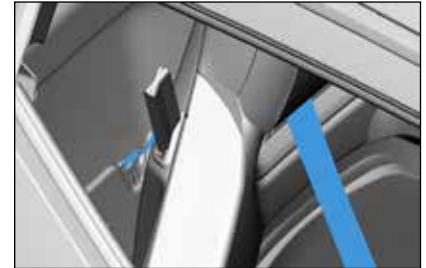



EVENT DATA RECORDERS

This vehicle is equipped with an event data recorder (EDR). The main purpose of an EDR is to record, in certain crash or near crash-like situations, such as an air bag deployment or hitting a road obstacle, data that will assist in understanding how a vehicle's systems performed. The EDR is designed to record data related to vehicle dynamics and safety systems for a short period of time, typically 30 seconds or less. The EDR in this vehicle is designed to record such data as:

- How various systems in your vehicle were operating.
- Whether or not the driver and passenger safety belts were buckled/fastened.
- How far (if at all) the driver was depressing the accelerator and/or brake pedal; and,
- How fast the vehicle was traveling.

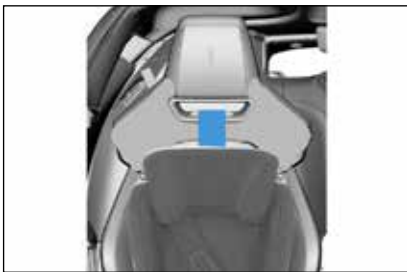

These data can help provide a better understanding of the circumstances in which crashes and injuries occur.

i *NOTE EDR data are recorded by your vehicle only if a non-trivial crash situation occurs; no data are recorded by the EDR under normal driving conditions and no personal data (e.g., name, gender, age, and crash location) are recorded. However, other parties, such as law enforcement, could combine the EDR data with the type of personally identifying data routinely acquired during a crash investigation.*

To read data recorded by an EDR, special equipment is required, and access to the vehicle or the EDR is needed. In addition to the vehicle manufacturer, other parties, such as law enforcement, that have the special equipment, can read the information if they have access to the vehicle or the EDR.

ELECTRIC VEHICLE SAFE-GUARD SYSTEM

Emergency First Responders Safety Loop

This system is designed to disable the high voltage in case of an accident. In case of a severe accident, first responder will cut the area indicated to cut off the wire harness 1 inside the driver's pillar to safely shut down the high voltage supply in the car allowing them safe extraction of the occupants of the vehicle.

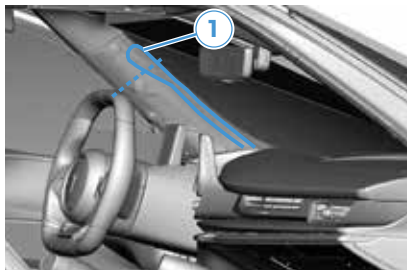

Pyrotechnic HV (High-Voltage) Fuse

Inside the Battista HV battery is a special pyro-fuse that can disable the high voltage system in emergency situation by means of opening the HV circuit. Triggered fuse disables the high voltage around the vehicle and allows for a safer condition for the occupants' egress as well as the first responders intervention.

⚠ *In case of an airbag deployment, the vehicle will be immobilized and will need to be towed to your nearest Automobili Pininfarina Service Partner who will be able to assist you. Your Battista will have to undergo a series of safety checks and repairs to ensure the vehicle's roadworthiness. Automobili Pininfarina can support you by sending out an expert to assess how to fix the vehicle and the pyrotechnic fuse embedded into the battery.*

High Voltage Interlock Loop (HVIL)

To make sure that all HV components are properly connected and protected, Battista is equipped with HVIL, a state-of-the-art system that ensures that all parts of the high voltage system are properly interconnected and protected. A

malfunction indicator  will be shown on the infotainment screen if the system detects a problem. Please contact your Automobili Pininfarina Service Partner as soon as possible and stop operating the vehicle if you see the above indicator displayed on the infotainment screen.

Do not attempt to tamper with High Voltage components to reset the warning.

High Voltage Service Disconnect Switch (HV SDS)

Your Battista may require maintenance work from time to time, and to safeguard the safety of the technicians working on the vehicle- Battista has a HV Service Disconnect Switch located under the driver's side of the dash near the A pillar.

This switch is used to safely power down the HV battery to prevent presence of HV during the repair and/or maintenance process. Automobili Pininfarina Service Partners go through comprehensive training courses to make sure their safety while working on the Battista is always guaranteed. The HV SDS should not be activated or deactivated in any normal situation by the Customer, including for long term storage of the BATTISTA.

i *NOTE Do not attempt to tamper with or modify this safety device in any way.*

TIRE PRESSURE MONITORING SYSTEM

Tire Pressure Monitoring offers the following functions:

- Permanent monitoring of tire pressure and temperature.
- Display of actual tire pressure (actual pressure) while driving.
- Tire pressure warnings.

The tire pressure warning light and a corresponding message on the instrument cluster warn. Each tire should be checked monthly when cold and inflated to the inflation pressure recommended by the vehicle manufacturer on the vehicle placard or tire inflation pressure label.

As an added safety feature, your vehicle has been equipped with a tire pressure monitoring system (TPMS) that illuminates a low tire

pressure telltale  when one or more of your tires is significantly under-inflated. The system also highlights the tire or tires with insufficient pressure graphically. Accordingly, when the low tire pressure telltale illuminates, you should stop and check your tires as soon as possible, and inflate them to the proper pressure. Driving on a significantly under-inflated tire causes the tire to overheat and can lead to tire failure. Under-inflation also reduces driving range and tire tread life and may affect the vehicle's handling and stopping ability.

Please note that the TPMS is not a substitute for proper tire maintenance, and it is the driver's responsibility to maintain correct tire pressure, even if under-inflation has not reached the level to trigger illumination of the TPMS

low tire pressure telltale. Your vehicle has also been equipped with a TPMS malfunction indicator to indicate when the system is not operating properly. The TPMS malfunction indicator is combined with the low tire pressure telltale. When the system detects a malfunction, the telltale will flash for approximately 70 seconds and then remain continuously illuminated. This sequence will continue upon subsequent vehicle start-ups as long as the malfunction exists. When the malfunction indicator is illuminated, the system may not be able to detect or signal low tire pressure as intended. TPMS malfunctions may occur for a variety of reasons, including the installation of replacement or alternate tires or wheels on the vehicle that prevent the TPMS from functioning properly. Always check the TPMS malfunction telltale after replacing one or more tires or wheels on your vehicle to ensure that the replacement or alternate

tires and wheels allow the TPMS to continue to function properly. The system consists of a radio-frequency transmitter sensor fitted to each wheel, which can send information on the inflation pressure of each tire to the control unit. Tire pressures can be viewed from the left display from the My Battista Performance Overview screen.



System may not show the pressures immediately if the vehicle has just been turned ON after an extended period of no driving activity. Some driving needs to take place before the values can be read back on the screen; this is considered normal as the sensors will go to sleep after some time of not detecting a tire revolution.

Performing a visual inspection and pressure check of the tires is always recommended even with the system in place. Additionally tire temperatures are shown to the driver, this temperature readout is helpful when adjusting pressures to a cold or hot setting. Refer to section "Rims and tires" in "Technical data" chapter for specifications.

Upon adding air to the tire, the system will reset on its own after the vehicle is driven to allow the new pressure to be registered.

⚠ WARNING: *Automobili Pininfarina does not recommend the use of different size tires and/or wheels other than the approved sizes that are listed on the tire and loading Information Label.*

⚠ WARNING: *The presence of the system does not permit the driver to neglect regular checks of the tire pressure and correct maintenance: the system is not used to signalling a tire fault, like wear to tire or any external damage.*

⚠ *Tire pressure must be checked with tires rested and cold. Should it become necessary for whatever reason to check pressure with warm tires, do not reduce pressure even though it is higher than the prescribed value. Repeat the check when the tires are cold.*

⚠ *Changes in outside temperature may cause tire pressures to vary. The system may temporarily indicate insufficient pressure. In this case, check the tire pressure when cold and, if necessary, restore the inflation values.*

ACOUSTIC VEHICLE ALERTING SYSTEM (AVAS)

An **Acoustic Vehicle Alerting System (AVAS)** is designed to emit **vehicle warning sounds** and alert pedestrians to the presence of electric drive vehicles. These include hybrid (HEVs), plug-in hybrid (PHEVs), and full battery electric vehicles (BEVs) travelling at low speeds, especially in the lowest speed range beyond which the noise generated by rolling tires can be easily heard.

This system cannot be switched off and emits a signature Battista sound while the vehicle is in motion.

The system's volume and intensity will change depending on drive mode and speed (refer to "Drive Mode" section in "Starting and driving" Chapter).

⚠ WARNING: *Other Road users may not be able to hear electric vehicles, such as the Pininfarina Battista, when they are driving as electric cars generate less noise than combustion engines. This increases the risk of collision.*

⚠ WARNING: *If you notice that the AVAS warning light has illuminated on the instrument*

display , the system has experienced a malfunction and needs to be inspected. Please reach out immediately to your Automobili Pininfarina Service Partner to have the malfunction corrected.



Read the following instructions carefully on how to use the system before operating the vehicle.

⚠ WARNING: Follow the safety precautions reported below; otherwise, injury to people or damage to the system could occur.

⚠ WARNING: Adjust the volume to always be able to hear ambient noises surrounding (e.g., horn, ambulances, police vehicles, etc.).

⚠ Clean the face of the display only with a soft, dry, clean, and antistatic cloth. Cleaning products could damage the surface; do not use alcohol, petroleum-based products, and their derivatives but only water.

⚠ Do not use the display as a base for suction cup supports or adhesives for external navigations or devices such as smartphones.

⚠ Avoid hitting the display lens with pointed or hard objects that could damage its surface.

ℹ NOTE Radio and Internet reception conditions change constantly while driving. Reception may be interfered with by the presence of mountains, buildings, or bridges, especially when you are far away from the broadcaster or cell signal tower.

⚠ WARNING: Distracted driving could result in loss of vehicle control, collision, and injury. Use extreme caution when taking your focus off the road. Look at the screen only when it is necessary and safe to do so. Your primary responsibility is the safe operation of your vehicle. If you need to look at the screen for a longer period, pull over to a safe place so as not to be distracted while driving.

INSTRUMENT PANEL

CONNECTIVITY

Your Battista comes equipped with a telemetry system that allows it to be connected to the Internet via its onboard modem. Currently these following countries are supported: Austria, Belgium, Bulgaria, Channel Islands, Croatia, Cyprus, Czech Republic, Denmark, Estonia, Finland, France, French Guiana*), Gibraltar, Great Britain, Greece, Guadeloupe, Hungary, Iceland, Ireland, Isle of Man, Italy, Latvia, Liechtenstein, Lithuania, Luxembourg, Malta, Martinique), Mayotte, Monaco, Netherlands, Northern Ireland, Norway, Poland, Portugal, Réunion, Romania, Saint-Barthélemy), Saint-Martin (French part)*), San Marino, Slovakia, Slovenia, Spain, Sweden, Switzerland, Vatican City, Albania, Andorra, Bosnia and Herzegovina, Faroe, Kosovo, Macedonia,

Moldova, Puerto Rico, Turkey, USA, Canada, Australia, Mexico, New Zealand, South Africa, Japan, Singapore, Taiwan, South Korea, Hong Kong, India, Monaco, Bahrain, Israel, Oman, Qatar, Saudi-Arabia, UAE and Kuwait.

If you find yourself driving Battista through a country that is not listed, your Internet services will not be available to you. Upon re-entry into a supported country please contact Automobili Pininfarina so your connectivity services can be re-established.

DISPLAYS

The functions, adjustments, and information useful to the user are divided into three separate displays:

- 1 Left display: located at the left of the steering wheel;
- 2 Central display: located behind the steering wheel;
- 3 Right display: located at the right of steering wheel.

Left/right displays are touchscreens, while the central screen is view only.

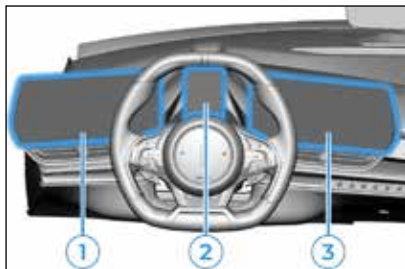

LEFT DISPLAY

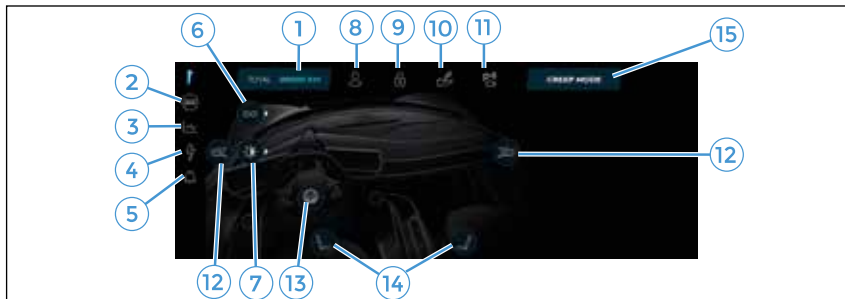

Left display main landing page allows you to access to the following settings:

- 1 On the top left of the screen the odometer value is shown.
- 2 Drive modes allow to see the specific pre-set parameters of each available mode and customize the Carattere mode to users' needs (for details refer to "Drive Mode" paragraph in "Starting and driving" chapter).
- 3 Trip Performance (for details refer to "trip performance" paragraph in "Starting and driving" chapter).
- 4 Charging information (for details refer to "Charging"

- chapter).
- 5 Notifications (for details refer to "instrument panel notification" paragraph in this chapter).
- 6 When pressing on the LIGHT icon the available light functions are opened to the right of the icon (for details refer to "External light" paragraph in "Controls and settings" chapter).
- 7 When pressing on the BRIGHTNESS icon the adjustment for auto brightness or manual brightness slider is shown to the right of the icon.
- 8 When pressing on the USER

icon the driver profile screen is shown.

- 9 When pressing on the LOCK icon the lock assistant screen is shown (for details refer to "Doors" paragraph in "Controls and settings" Chapter).
- 10 When pressing on the VALET icon the valet setup screen is shown (for details refer to "Valet Mode" section in "Controls and settings" Chapter).
- 11 When pressing on the CAMERA icon, the view camera feature is shown on RH screen (for details refer to "Surround view camera" section in "Starting and driving" Chapter).
- 12 When pressing on the MIRROR icons the exterior side-view mirror adjustment for the LH mirror is shown on the LH screen and RH mirror on the RH screen (for details refer to "Door Mirrors" paragraph in "Controls and settings" chapter).
- 13 When pressing on the STEERING WHEEL icon the steering wheel can be adjusted

(for details refer to “Steering wheel adjustment” paragraph in “Controls and settings” chapter).

14 When pressing on the SEAT icons the seats can be adjusted, driver on the LH screen and passenger on the RH screen (for details refer to “Seat” paragraph in “Controls and settings” chapter).

15 CREEP MODE (for details refer to “Creep Mode” paragraph in “Starting and driving” chapter)

i NOTE The F logo in the top left corner accesses the main landing page shown.

Additionally, both right and left touch screens allow you to swipe from one page to another by dragging your finger from the left or right of the screen to toggle between available options.

You can also swipe upwards to move between the available screens instead of pressing on the icons to the left of the left screen or to the right of the right screen.



CENTRAL DISPLAY



Central display allows you to view the following information:

1 Power Flow Meter – displays the instantaneous power flow coming from and going into the HV Battery (kW).

- 2 Turn indicator warning lights (left and right) when activated.
- 3 Drive Mode (selecting between CARATTERE, CALMA (default mode), PURA, ENERGICA, FURIOSA).
- 4 Gear selected (P R N D).
- 5 Current speed.
- 6 Navigation turn by turn indications (if navigation is set on) - (refer to “Navigation” below in this chapter).
- 7 State of charge (percentage).

i NOTE Vehicle will display estimated range in the lower portion of the central display, which is not shown on this graphic. This range will vary depending on your driving habits.

If navigation is not set, the display will show the current speed in a larger font.



i NOTE The vehicle range shown in any of the images showing the instrument cluster may not represent the actual range capabilities of the vehicle and are used only for illustration purposes.

RIGHT DISPLAY

Right display allows you to access information and entertainment content of the vehicle. Touching the menu icon on the right side you can enter in media player menu, navigation menu, phone menu, general settings and climate control settings.



GENERAL SETTINGS

From the right touch screen, touching the  button you can enter different car setup:

- 1 General:** under this setting the user can change settings such as:
 - Regional format of date and time, time zone selection.
 - Brightness and Clean Mode.
 - Units - temperature (C or F), speed (MPH or KM/h), pressure (bar vs psi).
- 2 Audio/Volume:** under this setting user can set their desired equalization levels to tailor the audio system to their desired frequencies.

Additionally, the system volumes can be adjusted here as well:

- Phone ring intensity;
- Phone loudness;
- Media loudness;
- Speech and navigation loudness;

-Parking distance controls loudness.

- 3 **Navigation:** under this setting the user can define routing for the system – for example avoid toll roads, ferries, highways. Smart routing can also be enabled to be aware of the traffic and vehicle's available range to optimize the route based on the scenario. Font size can also be changed between small, medium, and large for easier viewing.
- 4 **Connectivity:** In this setting users can pair their Bluetooth devices to the vehicle's infotainment system by clicking on the Bluetooth icon and following the instructions on the screen. Additionally, under the Connectivity settings one can also connect Battista to a wireless network via Wi-Fi. Connecting the vehicle to Wi-Fi will allow you to get over-the-air updates sent to your vehicle.

5 **Vehicle:** By clicking on this setting, a further menu will be presented with a few available options:

- Vehicle Info: will tell the user the VIN number of the vehicle.
- Automatic folding on lock/unlock: allows the user to set the mirrors to always fold in when the vehicle is locked and unfold when the vehicle is unlocked using the Key Fob.
- Vehicle Power Shut Down: this setting is to power off the vehicle completely, it is used for servicing the Battista by your Automobili Pininfarina Service Partner. The on-screen directions also inform the user how to re-power the vehicle prior to shutting it down.

⚠ WARNING: Do not attempt to shut off the vehicle with the trunk closed and closing the vehicle doors. Vehicle will no longer be able to power up, the only way to open the door is via the



mechanical key blade. To reset the vehicle back on after accidental shut down, a button 1 in the trunk compartment is available on the passenger side which allows you to set the power back on by pressing it.

i NOTE graphic above is shown with the cover removed exposing the coolant tank.

i NOTE a press of this button is ignored by the vehicle when it is powered On.

i NOTE if the trunk has not been opened prior to Vehicle Power Shut Down, a manual trunk opening procedure can be found in the Luggage Compartment

Liftgate section of this manual.

- 6 **Mobile App:** Under this setting, user can select an option to have Commands sent to the car as well as collect Data from the car. Both can be completely turned off and the Mobile App will not be able to connect with the car.
- 7 **System:** under this setting the user can select from the following sub-menus:
 - **System Info:** will display vehicle software version as well as its release notes, as well as storage information regarding how much memory is allocated to media for example.
 - **Updates:** will download the update automatically when the vehicle is connected to a Wi-Fi network. Download progress will be shown if an update is available. Once vehicle has downloaded a software package, it will allow the user to install it or schedule

an installation time when the vehicle is not being used.

- **Terms and Conditions:** legal statements regarding your privacy and how we process your data, as well as all other legal information.
- **Factory Reset:** This feature allows you to select multiple resets either your personal settings and or data. Factory reset will wipe all your personal settings and data that is stored in the vehicle to be wiped from the memory.
- **User Manual:** A QR code link is stored in the infotainment system. Which, when scanned with your mobile device will allow you to view a full digital version of the owner's manual. This in addition to the shorter physical printed version of the manual which is provided with each Battista.

MEDIA SOURCES



The Media player allows you to play various types of media through your car's speaker system. From the right touch screen touching on  button you can choose a source to play from

Radio, Car Storage, Bluetooth, or USB.

i NOTE following file formats are supported for USB audio - WAV, MP3, OGG, FLAC, AAC, AC3, VORBIS, DTS.

NAVIGATION

Vehicle features GPS-enabled navigation system to allow turn by turn directions to be shown on the right touch screen. System allows the user to see the current location marker on the map. It allows the user to search for destinations based on points of interest (POI) such as restaurants, charging stations, hotels. Additionally, home/work address can be stored for quick access to route guidance of a stored address. Vehicle takes battery status into account when route planning and displays this information on the screen.

From the right  button you can enter in navigation screen:

- 1 Search button: allows you to set destinations and look them up.
- 2 Day/night modes: allows you to choose day, night modes or AUTO.
- 3 Locate: allows to locate the car on map.
- 4 Map orientation: allows to show the car being driven north.



Once destination has been selected, the display shows you the turn-by-turn instructions to reach it. While driving the arrow down

near street instruction displays the route overview showing when the next turns are expected during the currently selected route. Touching the X button 1 and confirming by pressing the related button, you can end the navigation.



During navigation, the following information will be shown:

- Estimated time of arrival at destination,
- Time to travel as well as distance in miles or kilometers.

Additionally, Routing type will be shown here (fastest, shortest) and then estimated state of charge when arrived at destination.



Swiping the navigation screen, the display shows your possible destinations, the most recent 1, favorites 2 and charging stations 3 and input destinations will show their distance in KM or Miles.



It is possible to set different route options in the related menu in order to avoid toll roads, Motorways, Ferries. To turn on / off the options you must switch the buttons for the option you want to enable/disable. This is possible by pressing  and going into the Navigation and route option settings.



AUDIO

Battista is equipped with a state-of-the-art audio system developed in conjunction with Naim. It is set to deliver audio reproduction capabilities just as impressive as its driving performance.

Adjustments to suit the driver's needs can be performed using the built-in equalizer in the infotainment system as described under "General Settings" in this chapter.



i NOTE listening to the audio system at loud volume levels can harm hearing of the occupants of the vehicle.

MEDIA JOYSTICK

The center console mounted joystick (1) knob can control many features of the infotainment system. It has the ability to be used in 5 different axis by pressing it: left, right, forward, backwards and pressed down, as well as rotated.

- When rotated to the left/right - reduce/increase the volume of media (during active media) and phone call (during active phone call).
- When pushed forward - navigate through the selected section of the right screen to the left or right.
- When pulled backward - pause the song currently played from Media Player, when pulling back again - resume playing media.
- When pushed briefly towards left in the first 2 secs of the song - play previous song of the active media source except radio.
- When pushed briefly towards left in the last 2 secs of the song - play current song from the

beginning of the active media source except radio.

- When pushed and held towards the left while playing - start rewind of the song towards the beginning of the active media source except radio.
- When pushed towards right while playing - play next song.
- When pushed and held towards the right while playing - forward of the song towards the end of the active media source, except radio.
- When pushed from top - toggle mute/unmute of the currently played media, volume.



CONNECTING TO WI-FI

To connect your Battista to a wireless network, you first need to access the General Settings Screen and select Connectivity from the right screen. Upon which selecting WiFi you will be prompted with step-by-step directions on finding and connecting to a wireless network.



OVER THE AIR UPDATES (OTA)

In order to provide you with exhilarating as well as most up to-date Battista experience, Automobili Pininfarina may from time-to-time release over-the-air software updates. It is recommended that you connect your Battista to an available Wi-Fi network in order to have the ability to download the latest updates. It is recommended, that when prompted, you install the update whenever possible. You will not be able to drive the vehicle during this time, it is recommended that the update is done when you know that the vehicle will not be driven for extended period, such as overnight. Some updates may take longer than others to complete, depending on the size of the update and how many modules need updating.

It is recommended you keep the vehicle charged at above 50%

state of charge before attempting to update the vehicle.

No external devices are plugged into the on-board diagnosis port under the dash.

Vehicle is plugged in but doesn't need to be charging (refer to "Charging" Chapter).

Your Battista mobile app will notify you about the update and provide with instructions as well.

All information on the current software and potential updates can be found under the General Settings >> System>> Updates on the right infotainment screen.



PHONE

⚠ WARNING: *Distracted driving could result in loss of vehicle control, collision, and injury. We recommend against the use of any hand-held electronic devices whilst driving. Ensure you are aware of any applicable local laws that may affect the use of electronic devices while driving. Your primary responsibility is the safe operation of your vehicle.*

You can use your Bluetooth-capable phone hands-free in car; provided your phone is within operating range. Bluetooth performance can vary based on the phone you are using.

Using the buttons displayed on the screen you can: dial the phone number (using the graphic keyboard present on the display); view and call contacts in the phone book mobile phone; view and call contacts from recent call logs; mute the microphone system for private conversations.

Cellular phone audio comes transmitted through the audio system of the car: the system deactivates the car audio automatically when using the telephone function and placing or receiving a call.

i NOTE *To be able to receive calls using the vehicle's infotainment system, your phone needs to be paired - which is done using the General Settings on the right infotainment screen.*

⚠ WARNING: *Only pair devices when the vehicle is stationary and in a safe location.*

The procedure is described below to pair mobile phone: always consult the operating instructions for your given device prior to attempting to pair it.

To register the mobile phone, proceed as follows:

- Activate the Bluetooth function on the mobile phone.
- Access the “General Settings” by pressing  and “Connectivity”

- 4 to begin the procedure registration, then search for the Battista device on the mobile phone.

- When the device asks for it, insert with the keypad on your phone PIN code shown on the display of the system or confirm the PIN on the mobile phone displayed.
- When the registration procedure has ended successfully a message on the right screen will appear, by selecting “Yes” the mobile phone will now be registered. Your phone may ask you to consent for transferring of contacts and or data.





To pair the Phone in order to make phone calls using the hands-free system, an additional step needs to be executed.

- Click on the headset icon on the right-side menu – 
- Press- Connect Phone button.
- Select the device from available paired devices already stored within the Bluetooth system – or connect to another phone.
- Confirm pairing.



Main screen

Touching on headset icon button you can enter in phone main screen which shows selection of contacts that are set as *Favorites*.



Swiping to second screen the display shows you the recent and all contacts.



Clicking on the name the system will pull the contact data from the phone for each stored contact.



Swiping to third screen the display shows you the dial pad to enter a phone number.



In-coming calls

When your phone receives an incoming call, the screen displays the caller's name or number. Touching green  or red headset  you can respectively accept or reject the call.



Ongoing calls

You can make a phone call by choosing a number from your contacts or using the screen dialer. During the ongoing call screen, the user can choose to end, mute/unmute.



Deleting Bluetooth Device

Selecting the phone button  on the right-hand screen and scrolling over to the paired device, the user is presented with few options to make any changes to that device's settings.



By pressing the UNPAIR DEVICE button and following the prompts on the screen the device will be removed from the infotainment system.



CLIMATE CONTROLS

 **WARNING:** *The climate control system should be serviced only by qualified personnel as the refrigerant R1234YF is flammable and is under high pressure. Failure to follow proper service procedure may result in injury or damage to the vehicle.*

 *The system uses R1234YF gas, which does not pollute the environment in the event of accidental leakage. Under no circumstances use fluids which are incompatible with the components of the system.*

Climate control screen allows the user to set the desired temperature and air flow inside the passenger compartment - system can be either set to operate in fully automatic mode where desired temperature is maintained by either heating or cooling the cabin. System also allows for manual adjustment of the fan speed and distribution of the air via vents. System is of single-zone variety, meaning only one temperature can be set.

 **NOTE** *If LIMP- MODE is activated (refer to "Limp Mode" in "Starting and driving" chapter), performance of your vehicle will be greatly reduced, and the climate control system may be limited to preserve energy.*

To adjust individual settings to suit your preferences, access climate control settings from main menu of the right display touching temperature button 1 located at the bottom right of the display.



AUTO - touch AUTO button to activate /deactivate automatic function of climate controls. If AUTO is on, the system operates completely automatically to adjust the temperature, quantity and distribution of the air introduced into the passenger compartment. It also manages the

air recirculation system and the enablement of the air conditioning compressor. During automatic operation, you can change the set temperatures, activate/deactivate the compressor and the recirculation at any time by using the relevant buttons: the system will automatically change the settings to adjust to the new requirements.

OFF - Climate control completely shuts off the system.

A/C - Air conditioning on / off button. Turning it off reduces cooling but saves energy.

 Internal air recirculation on / off button and an Automatic setting. Recirculation function allows the system to either pull fresh air from the exterior or recirculate the air from within the passenger compartment. Depending on the exterior temperature, intensity of the sun and desired interior temperature - when set to automatic climate control mode, air intake (fresh or recirculated) will be selected by the systems control module.

+/- Temperature - touch the + or - buttons respectively to increase or decrease the air vent temperature when not in full auto mode. Temperature control provides the user to set the desired interior temperature that vehicle will maintain while in full AUTO mode.

+ / - Fan speed - touch the + or - buttons respectively to increase or decrease the fan speed level. Fan speed control provides the user with the ability to set the fan speed of the air circulation inside the cabin. Fan speed can be set automatically by the system if set to AUTO or manually by the user.

 **MAX -DEF** on / off button. Touch the button to activate the windscreen and side window demisting/defrosting function. It automatically sets the settings of the system to demist the windshield as soon as possible. Additionally, the exterior mirror heating will be turned on when the defrost function is selected.

Air direction control is the function of the system to change the direction of the airflow. Air can go to driver/passenger foot area, head, and torso area or to the windshield. It can also go into multiple direction at the same time.

 Air flow to ventilate face level.

 Air flow to ventilate foot level.

 Seat heating.

Seat heating levels provide the user with the ability to choose the level of heating of the seats, user can choose 3 levels of heating. The red lines near the seat's icon (driver or passenger) show the heating levels.

i *NOTE* The demisting/defrosting function (MAX-DEF) must be used with the soft top installed.

WARNING LIGHTS AND MESSAGES

The following indicators illuminate on instrument panel to advise you or alert you of a specific condition and they are divided in different colors (red, yellow, blue, and green), based on their type and severity.

Green: the green indicator lights indicate that a certain function is active.







Yellow: the yellow indicator lights indicate a function that is currently turned on/off or a malfunction that still allows for a careful continuation of drive.

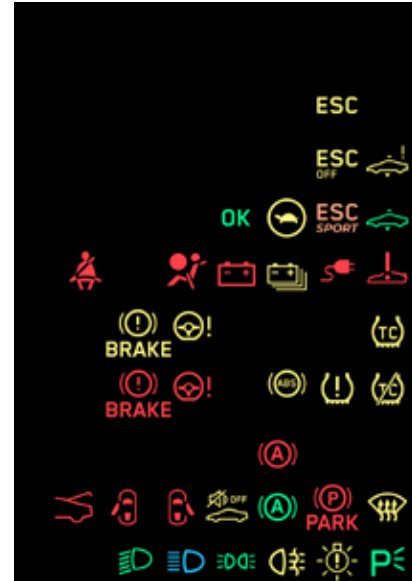



Red: warning light demands immediate attention - don't drive any further.

Blue: the blue indicator light informs the headlamp high beam is turned on.



i *NOTE* Some warning lights in the table below may only be present for specific markets.













Indicator	Description
	Headlamp beam The warning light switches on when the headlamp beam is turned on.
	Headlight high beam The warning light switches on when the headlamp high beam is turned on.
	Parking lights The warning light switches on when the parking lights are turned on.
	Position lamp (rear) The warning light switches on when the position lamp is turned on.
	Rear fog lamp The warning light switches on when the rear fog lamp is turned on.
	The warning light flashes green when the left turn signal is operating.
	The warning light flashes green when the right turn signal is operating.







Indicator	Description
	Both warning lights concurrently flash when hazard warning lights are turned on.
	The warning light switches on to indicate a stop lamp malfunction.
	If the warning light switches on, this indicates a failure in the airbag system.
	The warning light switches on to indicate charging cable is connected.
	The warning light switches on to indicate an electric vehicle system failure. A related message will appear on instrument panel describing the specific failure.







Indicator	Description
 	<p>Brake system malfunction If the warning light switch on yellow: a break in the wiring within the electrical transmission, or an electrical failure in the control of the parking braking system shall be signalled to the driver by the yellow warning signal.</p> <p>If the warning light switch on red: an electrical failure in the control or break in the wiring external to the electronic control unit(s) and excluding the energy supply shall be signalled to the driver by flashing the red warning signal.</p> <p>Low brake fluid level The warning light turns on when the level of the brake fluid in the reservoir falls below the minimum level, possibly due to a leak in the circuit.</p> <p>Brake lining wear-out condition The warning light switches on to indicate brake lining wear-out condition. Note: Brake disc and pad wear depends on the driving style and driving conditions.</p>

Indicator	Description
	<p>Electric parking brake on The warning light switches on when the electric parking brake is engaged. Release the electric parking brake, then check that the warning light has switched off.</p>
	<p>The warning light switches on constantly if the vehicle is stationary and the driver side or passenger side seat belt, with the passenger seated, is not fastened. The warning light flashes, and an audible notification will sound if the vehicle is in motion and the driver side or passenger side seat belt, with the passenger seated, is not correctly fastened.</p>
	<p>The warning light switches on to indicate an ABS fault.</p>

Indicator	Description
	<p>TPMS failure The warning signal flashes to indicate a malfunction. After a short period of time the warning signal remains continuously illuminated if the malfunction exists.</p> <p>Tire pressure low The warning light switches on to indicate that the tire pressure is lower than the recommended value and/or that slow pressure loss is occurring.</p>
	<p>ESC SPORT It indicates low amounts of intervention from the ESC system for sporty driving.</p>
	<p>ESC malfunction The warning light switches on to indicate a malfunction in ESC system.</p>
	<p>ESC turned off If displayed on the Instrument cluster, the ESC is inactive.</p>

Indicator	Description
	<p>Steering failure The warning lights switches on when a failure occurs in the power steering.</p>
	
	<p>The warning light switches on to indicate the State of charge of traction battery.</p>
	<p>If the warning light switches on, it can indicate multiple conditions: electrical charging condition, low voltage battery status info, power battery failure, drive motor failure or high temperature for power battery, etc.</p>
	<p>The warning light switches on to indicate the trunk is open.</p>
	<p>The warning light switches on to indicate the left door is open.</p>
	<p>The warning light switches on to indicate the right door is open.</p>

Indicator	Description
	The warning light switches on to indicate windscreen defrosting system is on.
	The warning light switches on to indicate limited performance mode (Limp Mode) is on, for details refer to “Limp Mode” section in “Start and Driving” chapter.
	The warning light switches on to indicate a suspension lift/lowering malfunction.
	The warning light switches on to indicate the suspension lift/lowering is currently enabled.
	The warning light appears to indicate that passenger air bag is turned on.
	The warning light appears to indicate that passenger air bag is turned off.
	The warning light appears to indicate that the car is ready for driving.

Indicator	Description
	The warning light switches on to indicate auto brake holding system is operating.
	The warning light switches on to indicate a malfunction in the auto brake holding system.
	The warning light switches on to indicate AVAS system has experienced a malfunction.
	The warning light switches on to indicate Traction Control system is off.
	The warning light switches on to indicate Traction Control system malfunction.
	The warning light switches on to indicate cruise control system is operating.

INSTRUMENT PANEL NOTIFICATION

Notification screen is accessed by the user on the left display by touching the bell icon.

This shows you 3 levels of notifications: errors, warnings, and information with text message.

Depending on the severity of the notification, the system can suggest to the user what to do and where to find contact details of partner dealer - if the alert requires workshop intervention.



ACOUSTIC NOTIFICATIONS

- **Welcome sound**

While the vehicle is turned OFF, when the user unlocks the vehicle, when the user opens driver door, the vehicle shall produce welcome sound.

- **Door, trunk ajar chime**

When a door or trunk is opened, while the vehicle is in R or D, while the vehicle speed is greater than 10 km/h or the vehicle moved for more than 100m from stand still, the vehicle shall start producing Door opened chime.

- **Turn indicators and hazard lights sound**

While the turn indicators are turned ON (refer to “External lights” section in “Controls and settings” chapter) or Hazard lights are turned ON (refer to “Hazard warning lights” in “In emergency” chapter) the vehicle shall produce a sound.

- **Incoming call sound (ringtone)**

While the phone is connected via Bluetooth (refer to “Phone” section in this chapter), when there is a phone call incoming, the vehicle shall produce a ringtone.

- **Call end sound**

While the phone call is ongoing, when the call ends or is dropped the vehicle shall produce a call ended sound.

- **Engage powertrain sound**

When the powertrain is engaged, the vehicle shall produce a powertrain engaged sound.

- **Notification message sound**

When the message notification is triggered on the display, the vehicle shall produce unique Message sound.

- **Notification warning sound**

When the warning notification is triggered on the display, the vehicle shall produce a unique Warning sound.

- **Notification error sound**

When the Error notification is triggered on the display, the vehicle shall produce a unique Error sound.

- **Seatbelt reminder sound**

While the driver or passenger seatbelt is not fastened, when the vehicle starts driving the seatbelt reminder sound shall be produced.

Seat belt warning light



The seat belt warning light and a warning tone reminds vehicle occupants to fasten their seat belts. The seat belt warning light extinguishes, and the warning tone ceases when the driver and passenger have fastened their seat belt.



CONTROLS AND SETTINGS

THE KEYS

The car is equipped with electronic keys with Keyless Start function.

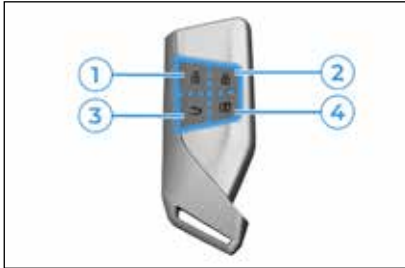

i NOTE The vehicle does not automatically unlock when approaching, similarly it can not lock when leaving the vicinity of the vehicle. It requires user's input via the key fob remote control to operate the locks.

Using the key

Doors and tailgate unlocking

Briefly press the button 1: unlocking of doors and tailgate, vehicle will exhibit timed switching-on of exterior lights, interior lights and single flashing of direction indicators.

i NOTE The key fob has a range up to 20 meters, it is recommended to replace the fob battery yearly. If the battery is flat, please refer to "Replacing the electronic key battery" section for the correct procedure to replace the battery and/or refer to "Driver side door emergency opening" section below for the emergency procedure to unlock the door.

Doors locking

Briefly press the button 2: locking of doors, vehicle will exhibit timed switching-off of exterior lights, interior lights and double flashing of direction indicators.

Rear storage compartment opening

Press the button 3 for 3+ seconds to open the cargo compartment remotely.

Remote window opening/closing function

Pressing of button 1 for 4 seconds: all windows open.

Pressing of button 2 for 4 seconds: all windows closed.

i **NOTE** when windows are rolling closed or open, releasing of the button stops the window movement. This allows the user to leave the windows in a desired position remotely. Pressing of the button again for 4 seconds will resume the movement of the window in the desired direction.

⚠ **WARNING:** *Incorrect use of the electric windows may be dangerous. Although this vehicle is equipped with “anti-pinch” automatic reversal window system, before and during operation, always check that nobody is exposed to the risk of being injured either directly by the moving window or through objects getting caught or hit by it.*

Charge port lid opening

Press the button 4 briefly once to light up the charging status light

on the  E-Heart, located in the rear of the vehicle.

Press the button 4 longer (minimum 3 seconds) to unlock the charge port lid.

For detailed charging procedures, including important safety information, please refer to “Charging” chapter of this manual. The key has a Radio Frequency Identifier (RFID) chip built into it that will allow you to start the Charge Point charging station using the Battista key. The key will be linked to your Charge Point profile, that needs to be activated before 1st charging session.

RFID equipped key will allow you to start, stop the charging session and make payment* with the charging station

*When the free charging is up.

⚠ *The operation of the key fob recognition system depends on various factors, such as, for example, any electromagnetic wave interference from external sources (e.g., mobile phones), the charge of the battery in the electronic key and the presence of*

metal objects near the key or the car. In these cases, it is still possible to unlock the doors by using the metal insert in the electronic key (see description on following pages).

Welcome light function

This feature allows you to turn on the lights when you are near the car to better see the surrounding area. The puddle lights located in the mirrors will shine light down on the ground, in combination with the front headlights and rear taillights.

It is used to find the vehicle in darkness but also to illuminate area in front and rear of the vehicle when approaching for increased personal safety.

This feature works in low light situations as it uses the light sensor to determine if the light shall be illuminated. To activate the welcome lights; press the unlock button on the key fob (add link to fob) which will unlock the doors and illuminate the lights.

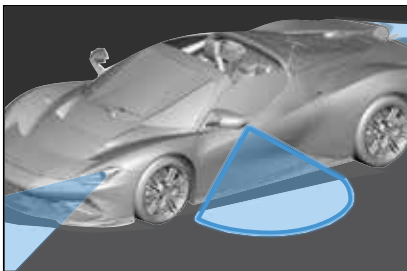

Door Courtesy Lights

When either one of the doors is opened, an additional courtesy light will illuminate from the door trim panel down on the ground to further brighten the entry into the vehicle.



Driver side door emergency opening

If the electronic key does not work, e.g., because its battery is flat or the car battery is flat, the key blade insert inside the key can be used to operate the lock, unlocking the driver side door.

To extract the physical key blade, proceed as follows:

- Remove the key blade insert from its housing pulling out from the fob; there is no switch to be pressed for release, just pull out the blade and the internal spring will release it.

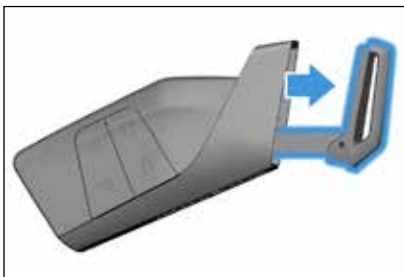

- Insert the key blade in the driver side door lock 1, located next to door handle, and turn it to unlock the door.

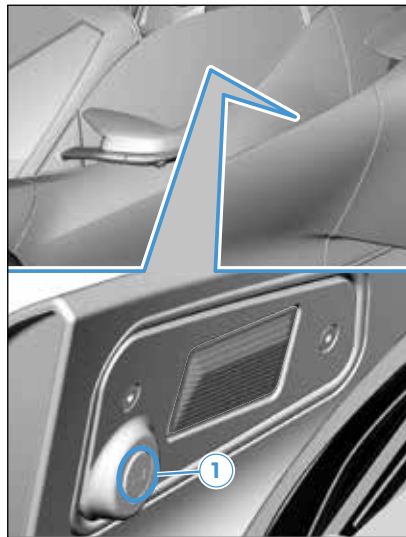

- Place the key in its cubby holder in the center console so it can be detected by the system to start the car.



Replacing the electronic key battery

To replace the battery (type: CR2032), proceed as follows:

- Remove the key blade insert from its housing pulling out from the fob (refer to “Driver side door emergency opening” in the paragraph above).
- Unclip the key body 2 from the lash 1 by pulling apart as shown below.

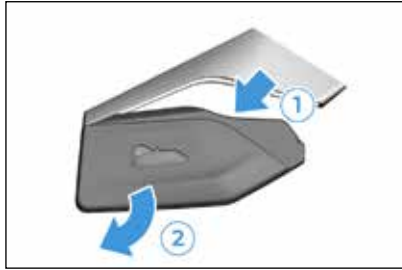

- Insert the key blade (3) into the slot as shown below, turn it (step 4) to disassemble the key body (5).



- Remove the battery 1 from its slot and replace it with a new one of the same type.

i NOTE When installing the new coin battery into the remote, please pay attention to insert the battery with the correct polarity orientation.



Proceed in reverse order to reassemble the key.

IMPORTANT The battery replacement operation must be carried out with care, in order not to damage the electronic key.

i **NOTE** In an event that the key fob battery needs replacement due to age, a message in the notifications section of the left screen will be shown.

! *The electronic components inside the key may be damaged if the key is subjected to strong shocks. To avoid damage of the electronic devices inside the key, avoid contact with high temperatures, liquids, solvents, waxes, and abrasive cleaners.*

♻️ *Used batteries may be harmful to the environment if not disposed of correctly. The batteries must be disposed of as specified by law in your local area or taken to an Automobili Pininfarina Service Partner, which will take care of their disposal for you.*

! **WARNING:** *Always take the key with you when you leave your vehicle to prevent someone from accidentally operating the controls or driving off with the vehicle. Never leave children unattended in the vehicle. A child could activate the electric window winders, other controls or even start the vehicle.*

SILENT ALARM

Alarm activation

The alarm activates, and a notification will be sent to the mobile phone app notifying of alarm trigger, in the following cases:

- If a locked door or luggage compartment is opened in the absence of a valid electronic key.
- Attempting to enable vehicle propulsion with an invalid electronic key.

Switching on the alarm

With the doors, liftgate closed, and windows rolled up point the electronic key towards the vehicle and press the lock button (button 2). Activation of the alarm illuminates the turn signal indicator lights twice, for a visual confirmation of set on condition.

Additionally if the Power Fold Mirror feature is turned on; exterior mirrors will automatically fold in to indicate the doors have been locked and alarm has been set (refer to section “Power fold mirrors” in this Chapter).

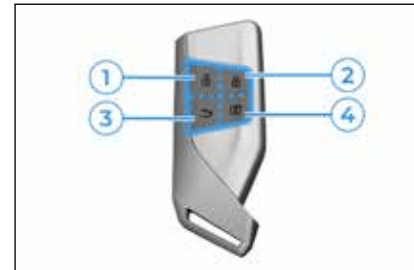

Turning the alarm off



Press the unlock button of the electronic key (button 1) or use the key blade in the door lock.

The following operations are performed: illumination of the direction indicators once, doors are unlocked.

Additionally if the Power Fold Mirror feature is turned on; exterior mirrors will automatically fold out to indicate the alarm has been disarmed (refer to “Power fold mirrors” section in this Chapter).

DOORS

Locking/unlocking doors from the inside

Press the A button  on the dashboard, to lock the doors. With doors locked, press the A button  to unlock them.

⚠ WARNING: NEVER leave children unattended inside the car, let alone leave the car with the doors unlocked in a place that

children can access easily. Children may seriously, or even fatally, injure themselves. Also ensure that children do not inadvertently operate the electric parking brake, the brake pedal, or the rotary gear selector dial.

⚠ WARNING: DO NOT drive the car with the door open.

⚠ WARNING: If doors are not closed properly the warning lights

 or/and  will appear on the instrument panel.

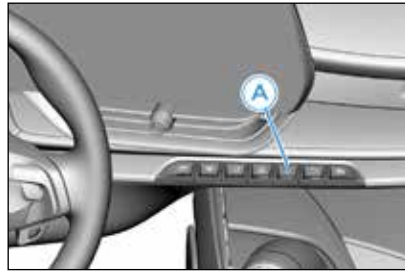

Locking/unlocking doors from the outside

With the doors closed, press button 2 on the key. Press button 1 on the key fob to unlock the doors.

i NOTE you can open the windows by pressing the unlock button 1 on the key fob and holding it to lower the window rolls down, in addition the windows can be closed by holding the 2 – lock button.

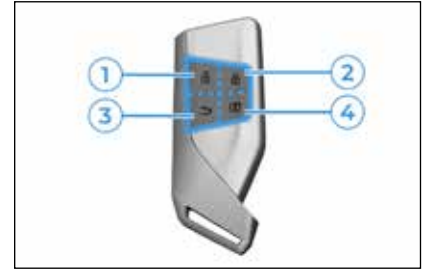

Doors opening

Once doors are unlocked, touch the soft-touch switch area to open doors.

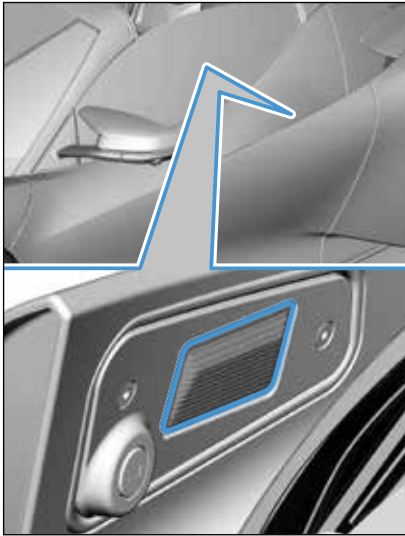

i *NOTE In sub-freezing weather conditions, it is possible that the doors may not remain fully open. Please exhibit caution when opening the doors.*

Battista is equipped with a window short-drop feature that allows the doors to be opened with the roof in place without the window glass interfering with the roof seals during opening of the door. When the door handle is utilized to open the door, the window glass will short-drop to allow for ease of door opening – when the door is closed the window again will roll back up.

i *NOTE: In case of a vehicle issue rendering shut down of the electrical system, it may not be possible to open the doors due to the windows potentially being closed. However, the vehicle will detect a problem and it will roll down to a set position to allow the door to be opened.*

Accessing the luggage compartment

Approach the Liftgate with a valid electronic key and press the opening button 3 on the key fob for 3+ seconds to access the luggage compartment. The trunk compartment will fully open automatically but pressing button 3 momentarily will stop the glass immediately while its opening.

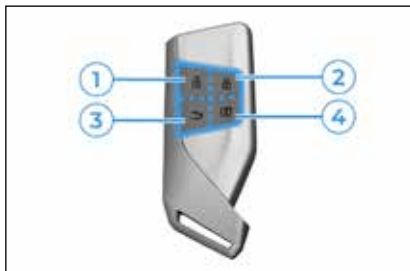

Pulling the button 6 on the center dash upwards for 3+ seconds will open the rear luggage compartment, pressing it down for 3+ seconds will close the luggage compartment. Note when closing the liftgate, the button must be depressed until the liftgate closes

and the trunk open light  is no longer illuminated on the left screen.

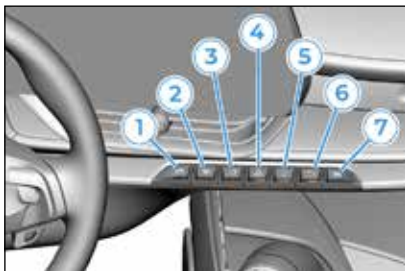

i *NOTE* opening and closing of the trunk is only possible with vehicle stationary.

There is an auxiliary release for the luggage compartment in case of a power issue where electric liftgate can't be powered open, see paragraph "Tailgate opening in case of electrical issue" in this chapter.

⚠ WARNING: *Rear trunk does not contain any sensors to detect an obstacle when opening or closing. Please be careful when closing the rear trunk compartment, keeping any objects, items or people away from the closing compartment.*

Passive entry

The system can identify the presence of an electronic key near the doors.

The system enables the doors to be locked/unlocked without pressing any buttons on the electronic key. If the detected key is valid, the doors are unlocked.

Lock/unlock car assistant on display

Lock car assistant button is accessed by the driver via the main landing screen of the left display. Touching the padlock icon 1 of the touchscreen you can enter the lock/unlock menu.

Lock/unlock car assistant screen allows you to lock/unlock the driver and passenger door by touching the relevant padlock icon 3, to unlock the charge port by touching the lightning bolt/padlock icon 2 or to lock concurrently all the doors by touching the icon 1.

i NOTE for detailing charging procedures, including important safety information, please refer to “Charging” chapter of this manual.”

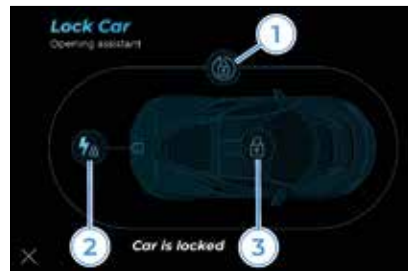

REMOVABLE SOFT TOP

The car is equipped with a soft top that can be removed manually. It combines ease of use and protection against weather agents.

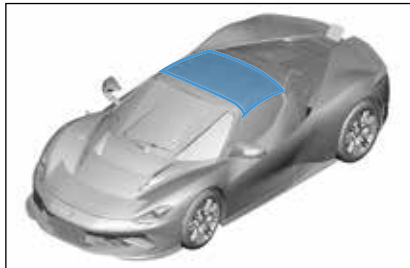

⚠ WARNING: *Before starting the car make sure the soft top is correctly locked in place. It is recommended not to remove/install the soft top with people sitting in the car, as the soft top could fall in the passenger compartment while it is moved. Be careful while installing/removing the soft top to prevent any damage or injury.*

⚠ *Never open the soft top in presence of snow or ice to prevent damage.*

⚠ *Loads may not be placed on the vehicle roof while its installed.*

⚠ *The removable soft top is intended for use in situations of unfavorable weather conditions. Due to the soft top not being waterproof, sustained usage in unfavorable weather conditions can introduce water into the cabin. It is advisable not to leave the vehicle outside with the removable soft top on for a sustained period of time.*

- With the help of another person, unfold and extend the soft-top over the top of the car;

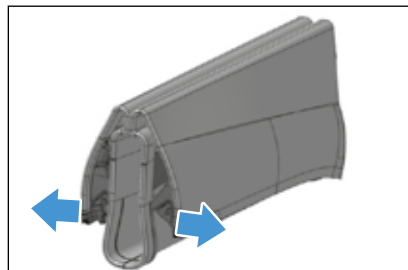

- insert the front dowel locating pins (1) into the top of the windshield frame (2);

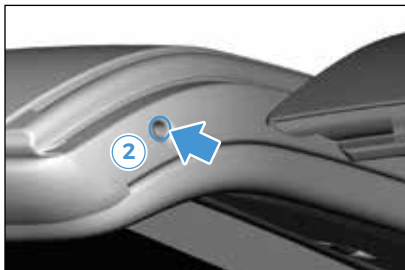

- press the rear part of the soft top downwards;

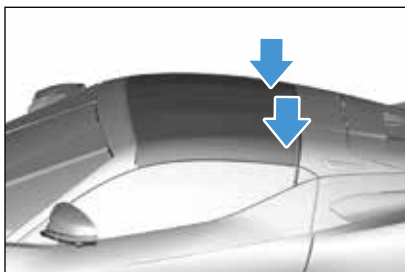

- slide the latch (3) towards the rear of the vehicle to lock the roof in place;
- repeat the same on the other side of the vehicle.

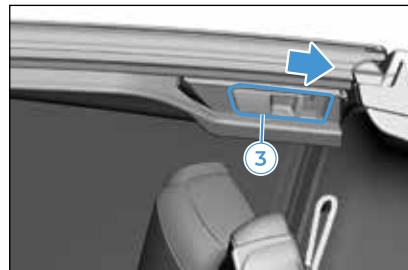

- Insert the strap through the head restraint portion of the passenger seat as show in image. Clip the belt to form a loop that will aid in holding the roof in place.

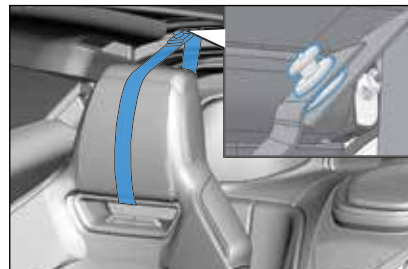

⚠ WARNING: *Safety strap must always be utilized when the removable soft top is installed.*

To remove the soft top, proceed as follows:

- remove the safety strap;
- standing outside the car with the windows down, reach into the vehicle and slide the latch mechanism (3) towards the front of the vehicle;
- lift the rear part of the soft top;
- release the pins (1) from their seats (2);
- remove the soft-top and store it in a safe dry place.

Important notes

- The demisting/defrosting function (MAX-DEF) must be used with the soft top installed.
- Do not attempt to remove ice from the soft top with sharp objects.
- Do not place objects on the soft top, as they could fall causing damage or injury.
- It is advisable to cover the with a car cover if the car is left parked in the open for a long time.
- Do not keep the soft top folded for a long time: this could cause folds and creases in the fabric.

⚠ WARNING: *Maximum speed with the soft top INSTALLED is 50MPH or 80KM/h.*

Washing/cleaning the soft top

Use of specific products is recommended for washing the soft top cloth.

It is recommended to wash by hand.

Remove as much dirt from the surface of the soft top with a soft brush or vacuum

cleaning before washing it. This operation will considerably improve the final result.

In lack of specific products, use water and mild soap applied with a sponge (preferably in the shade) for washing.

Rinse the soft top with clean water after having eliminated all the stains.

Leave the car in the shade after washing avoiding direct sunlight.

 Bird droppings and plant resins must be washed off the soft top immediately as they can permanently damage its fabric.

 Never use high-pressure washing systems or automatic-type car washes.

 Never use alcohol, petrol, chemical products, detergents, stain removers, wax, solvents and “wash and polish” products. Rinse immediately to remove soap to prevent stains and halos. Repeat the operation if needed.

Interior top fabric

Remove dust with a soft brush, avoid using hard brushes to prevent damaging the fabric.

Clean the surface with a microfiber cloth or soft sponge dipped in a solution of water and mild soap. Clean the entire surface, including the zones where cleaning is not needed, to prevent halos or staining.

Use common, car care mild stain removers for more stubborn stains.

Apply by blotting (never rubbing) directly on the area of the stain.

BONNET

Due to the great performance capabilities of the Battista, the front bonnet is constructed out of carbon fiber that can sustain high amounts of downforce and aerodynamic loads at extreme velocities. In order to achieve these performance targets the bonnet on the Battista is fixed shut and can only be removed by your Automobili Pininfarina Service Partner for service needs.

SEATS

The front seats can be adjusted to ensure maximum comfort for the occupants.

The seat must be adjusted so that the entire sole of the foot presses on the brake pedal when it is fully depressed; at the same time, your right leg must be bent slightly. In this way, in the event of emergency, the driver can generate sufficient force to achieve adequate pressure on the brake pedal. Moreover, this reduces the risk of leg injuries in the event of an accident.

The backrest must provide the driver with appropriate support and lateral containment on bends. To guarantee correct support, the backrest must be adjusted so that it is almost vertical, and the backrest supports the entire torso.

The seat must be adjusted to the lowest possible position, to achieve optimum perception of the car's movement and awareness when driving. The height of the seat must always take the driver's stature into account: the optimal awareness attainable through a low driving position must never compromise external visibility from inside the car.

Should it be necessary, it is advisable to adjust first the height of the seat, before concentrating, in the following order, on lengthwise adjustment, backrest angle adjustment and finally steering wheel position adjustment.

⚠ WARNING: All adjustments must be made with the car stationary. Do not adjust seats while driving, as this increases the risk of collisions.

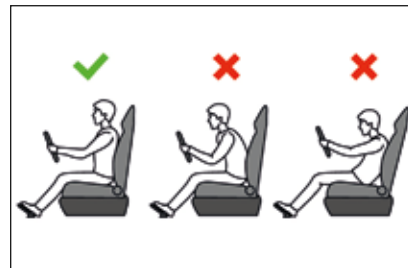

⚠ WARNING: Always make sure that all those on board the car are seated and are wearing their seat belts correctly. See Safety chapter for important safety information regarding seat belts.

⚠ WARNING: Do not operate the vehicle with seats reclined greater than 30 degrees, as this increases the risk that you could slide under the lap belt in the event of a collision, leading to serious injuries.

⚠ WARNING: Each seat is equipped with a headrest. The headrest is integrated with the seat, the headrest cannot be independently adjusted apart from the seatback. Properly adjust the seatback to a position so that the headrest is positioned as close as possible to the back of your head. An improperly positioned headrest could lead to serious injuries in the event of a collision.

Driver seat actuated adjustment

Driver seat has actuated adjustment of the height, longitudinal, backrest angle and lumbar position.

Adjustment is accessed by the driver via the main screen of the left display. You can access the adjustment menu by touching the seat icon 1 (driver seat) or 2 (passenger seat) of the left touchscreen.



By touching the related arrows on the touchscreen, you can make seat adjustment to find your desired settings.



To adjust lumbar settings, it is necessary to touch the related button to enter in the lumbar adjustment menu, by touching + or – buttons it is possible to find the desired setting.

i NOTE Only the standard GT seats can adjust the lumbar support, optional Pilota seats do not feature adjustable lumbar support. The infotainment screen will not have this option available if the vehicle is configured with Pilota seats.



Driver seat automatic actuated adjustment

Automatic actuated adjustment is the feature of the seat to be adjusted automatically from seat memory that is linked to driver profile or for easy entry.

Seat memory is linked with driver profile functionality of the vehicle. When the seat, mirrors or steering wheel are changed manually, a message will appear on the display asking if they would like to save this setting to their driver profile.

⚠ WARNING: *When automatic actuated adjustment is activated, the areas of the moving elements need to be cleared out. Always check that nobody is exposed to the risk of being injured by the moving of seats or steering column and wheel.*

Passenger seat actuated adjustment

Passenger seat has actuated adjustment of the height, longitudinal, backrest angle and lumbar position.

Adjustment is accessed by the user entering in the main screen of the right display. By touching the seat icon of the touchscreen, the user can enter in the adjustment menu. By touching the related arrows on the touchscreen, you can make seat adjustment to find the desired settings.

To adjust lumbar settings, it is necessary to touch the related button to enter in the lumbar adjustment, by touching + or - buttons it is possible to find the desired settings.

Easy entry

Easy entry is a comfort function of the vehicle that is providing the user with the ability to enter and exit the vehicle by moving the driver seat and steering column to a position that provides more space for entry more easily.

When the vehicle is disengaged off by pressing the power button on the gear selector knob (insert link to knob) the seat and steering column will move to a position that provides more space for exiting of the vehicle. When the vehicle is engaged on using the gear selector knob, the seat and steering wheel will adjust to the predefined setting for the user.

Access seat and steering wheel adjustment by touching the seat icon or steering wheel icon in the main menu of left display, you can choose to enable/disable the function by swiping the Easy Entry button on the touchscreen. If disabled, seat and steering column will not go to easy entry position when entering/exiting the vehicle.



When the seat, mirrors or steering wheel are changed manually, a message will appear on the display asking if they would like to save this setting to a driver profile.

NOTE: only available if there is a driver profile stored in the vehicle.



Seat heating

⚠ WARNING: *Prolonged use of the seat heater function at highest levels of its intensity could cause potential damage to human skin.*

Seat heating provides the vehicle with the ability to heat driver and passenger seat to increase user comfort in low temperature conditions, users can choose 3 levels of heating.

Seat heating setting is available in the right display via the climate control menu (for details refer to “Climate controls” paragraph in Instrument Panel Chapter) and touching the seat icon at the bottom of the display.

The red lines 1 and 2 near the seat icons (driver or passenger) show the heating levels, 3 lines being the highest, 2 lines being medium and 1 line being low seat heating.



STEERING WHEEL

Adjustment

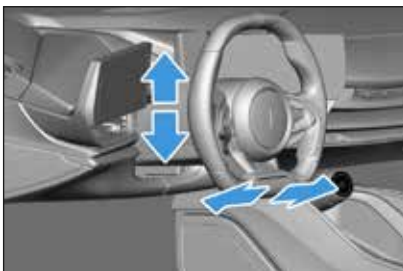

The steering wheel can be adjusted both in height and in depth.

⚠ WARNING: All adjustments must be carried out only with the car stationary. Do not adjust the steering wheel while driving.

Adjustment is accessed by the user via the main screen of the left display.

You can access the setting menu by touching the steering wheel icon of the touchscreen. By touching the related arrows (up, down, right, left) on the touchscreen you can make the adjustment to find the desired settings.



Controls on steering wheel

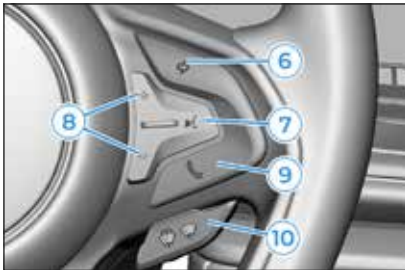
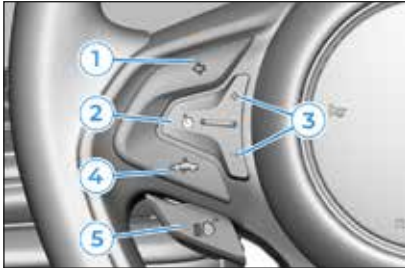

The steering wheel contains the following controls:

- 1 Indicator left
- 2 Cruise control ON/OFF
- 3 Cruise control speed +/-
- 4 Lift function front/rear
- 5 High-beam ON/OFF - flash
- 6 Indicator right
- 7 Voice Assistance activation*
- 8 +/- Volume
- 9 Phone accept/decline call
- 10 Windshield washer and wiper

*Features may not be available at Battista launch.

CONTROLS ON DASHBOARD

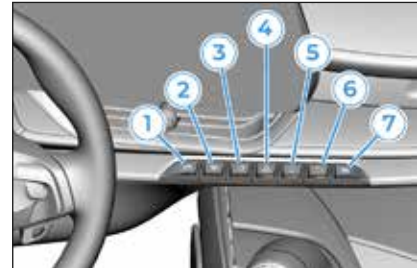

The following controls are located on the central dashboard:

- 1 Front left window opening/closing button
- 2 Front window fast defrosting button / demisting function
- 3 Rear fog light button
- 4 Hazard light activation/deactivation button
- 5 Lock/unlock door button

- 6 Lock/unlock and opening / closing of rear storage compartment
- 7 Front right window opening/closing button

AIR DIFFUSER

The car is equipped with adjustable side/central air diffusers and fixed air vents for the windscreen and side windows.

Adjustable Side / central air diffusers

- Central air diffuser: turn ring A to adjust the air flow.
- Side / central air diffusers: Move ring nut B up and down to adjust the frontal horizontal fins.

Turn ring nut B to adjust the flow.

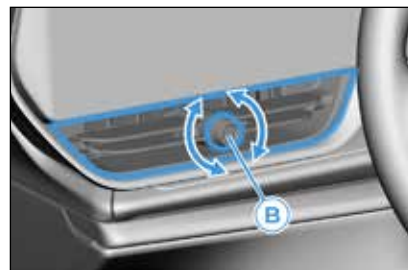

REAR VIEW MIRROR

Interior mirror

Interior Rear-view Mirror

Adjust the rear-view mirror for a clear view of the area behind your vehicle.

FULL (LCD) Liquid-Crystal Display INTERIOR MIRROR

In order to improve the rear visibility, the car is equipped with a full LCD interior mirror which reflects images from a camera mounted in the rear tail section, in the top of the rear fascia below the rear wing.

⚠ WARNING: Always check to ensure that the area around the vehicle is free of obstructions. Check outside mirrors and glance over your shoulder before reversing, when making lane changes, or merging. Never depend solely on the camera to detect objects that could potentially cause injury or

damage, use your own eyes and side mirrors. Objects may appear closer in the Full LCD Interior Mirror than they are. The rear-view camera is not designed as a substitute for responsible driving.

⚠ Dirty or obstructed camera lenses can negatively impact the performance of the rear-view camera. Do not use abrasive or harsh chemical cleaners, as this may damage the lens.



The mirror display contains 3 buttons and a toggle-switch:

- Button 1: settings / menu button.
- Buttons 2 and 3: adjustment buttons.

Switching from the traditional reflective mirror to the rear camera view and vice versa can be done by pressing a toggle-switch (4) located on the mirror.

i NOTE Driving in adverse conditions can make viewing the rear-view mirror display unclear, as the rear-facing camera can be covered by elements such as snow, rain or dirt making vision difficult.

Brightness camera adjustment menu

To adjust the display brightness, press the settings button 1 to select the  icon. Press left adjustment button 2 to darken or press the right adjustment button 3 to brighten. There are 5 brightness options.

Camera viewing angle adjustment menu

To adjust the camera viewing angle up or down, press the settings button 1 until the  icon is selected. Press the left adjustment button 2 to move the image downward or press the right adjustment button 3 to move the image upward. There are 9 camera viewing angle options.

Dimming function

The display is equipped with an automatic dimming function at night.

! WARNING: *Initial failure displays alert symbol and instructs to switch to mirror display. Failsafe warning continues as long as fault is present. No image is available through camera.*

DOOR MIRRORS

! WARNING: *Door mirror glass is curved, objects in the mirror may be closer than they appear and alter perception of distance.*

Left mirror adjustment is accessed by the user entering in the main screen of the left display (refer to “Left display” section in “Instrument panel” Chapter). You can access the adjustment menu by touching the mirror icon of the touchscreen. When pressing the mirror adjustment icon on the left screen in the quick setup menu, the mirror adjustment left opens on the left screen and simultaneously the adjustment for the right mirror will open on the right screen. You can make mirror adjustment by touching the related arrows (up, down, right, left) on the touchscreen to find the desired settings.



Power Fold Mirrors

Mirrors can be folded in and out using the 1 button that will fold in both exterior mirrors one at a time. For example, if driving into narrow spaces this feature allows the driver to have control over the extended mirrors to make the car narrower.

i NOTE *graphic shown is the left mirror, right mirror fold in will be shown on the right touchscreen.*

Mirrors can be set to automatically power fold in and out by selecting the switch 2 on the screen.

When this option is selected, both mirrors will fold in when vehicle is locked and unlocking will command the mirrors to unfold (refers to “The Keys” section in this chapter).



Heated Mirrors

Side mirror heating will be turned ON automatically and cycled when the ambient temperature is below 3 Celsius or 38 Fahrenheit. Additionally, the mirror heating will be also turned on if the driver selects front window defrost mode via the heating and ventilation controls (refer to “Climate controls” in “Instrument panel” Chapter).

EXTERNAL LIGHTS

⚠ WARNING: *While daytime running lights are automatically activated when the vehicle is powered on, rear taillights are not. Turn on rear lights in low visibility conditions, failure to activate rear lights may increase the risk of collision or injury.*

⚠ WARNING: *Ensure that headlights are on in low visibility conditions. Failure to activate headlights may increase risk of collisions and possible traffic violation.*



By pressing the power switch to start driving (refer to “Starting and driving” chapter), the daytime running lights (DRL) are automatically activated by illuminating the center combination light 1. DRL turn off when the vehicle is powered off.

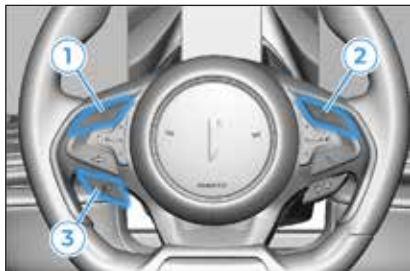

By pressing the power switch to start driving (refer to “Starting and driving” chapter), the daytime running lights / low beam are automatically activated. External light controls are located on the steering wheel:

- 1 Indicator left activation button. Tapping the turn signal button quickly allows 3 blinks, holding the button for 1 second allows turn signal to stay on. The direction indicators turn off automatically when the steering wheel is brought back to the center position. Additionally, pressing either one of the turn signal indicator switches on the steering wheel once more, will turn off the indicators.
- 2 Indicator right activation button.

Tapping the turn signal button quickly allows 3 blinks, holding the button for 1 seconds allows turn signal to stay on. The direction indicators turn off automatically when the steering wheel is brought back to the center position. Additionally, pressing either one of the turn signal indicator switches on the steering wheel once more, will turn off the indicators.





- 3 Pressing the paddle will turn the high beam ON or OFF.

i NOTE This is only possible if the headlights are illuminated via low beam. Pressing the paddle again will turn OFF the high beams. Pulling the paddle towards the driver will actuate the high beams regardless of if the headlights are ON or OFF.

i NOTE Lights will remain ON as long as the driver is pulling on the paddle, releasing it will shut OFF the high-beam lights.



In the main screen of left display, you can find the control menu of the exterior lights.

- 1 **OFF** touching the button on the touchscreen exterior lights are off (DRL stays on with car ON in Drive).
- 2 **AUTO** touching the button on the touchscreen exterior lights automatically turn on if the car detects low lighting condition.
- 3  Low beam on/off button
- 4  Position lights on/off button

- 5  Parking lights on/off button. Turning on the Parking lights and turning off the car, it will leave the parking lights on while the car is OFF. This is useful for example to indicate to oncoming drivers that a car is parked on the side of the road. When this feature is turned on.





Welcome and position lights / number plate lights



Low beam lights



STOP lights



Reverse lights



i *NOTE* The illuminated F-logo on the front is an available option and it is not standard on all cars.

Fog light



USA and Canada market only – side marker lights

Headlights adjustment

⚠ WARNING: *Your headlights have been adjusted to the recommended settings by Automobili Pininfarina to ensure optimum positioning. Contact us for assistance to adjust headlights.*

The correct orientation of the headlights is important for the driver's comfort and safety as well as for all other road users.

This is also covered by a specific rule of the highway code.

The headlights must be correctly aimed to ensure the best visibility conditions for all drivers.

If necessary, contact your Automobili Pininfarina Service Partner to have the headlights checked and adjusted.

READING LIGHTS

You can access the control menu for the interior lights by entering in General settings screen touching the  icon on the right main screen.

- 1 Driver's reading light: touching the switch will turn on/off driver's reading light.
- 2 Passenger's reading light: touching the switch will turn on/off passenger's reading light.



Dimming function

The function allows you to increase or decrease the brightness of the instrument panel.

In the main screen of the left display, tapping the settings icon you can find the control menu of dimming function.

- 1 **AUTO** touching the button on the touchscreen the function automatically adjusts the brightness of instrument panel basing on external lighting condition.
- 2 Touch the button to decrease instrument panel brightness.
- 3 Touch the button to increase instrument panel brightness.



AMBIENT LIGHTING

Battista's interior is equipped with LED interior ambient lighting which can be customized as the user prefers in a few different ways or be switched off.

When selecting the Drive Modes (refer to “Drive mode settings” section in “Starting and driving” Chapter) the interior ambience color choice will change with each mode chosen.

- Calma Drive Mode – Green.
- Pura Drive Mode – Blue.
- Energica Drive Mode – Orange.
- Furiosa Drive Mode – Red.
- Carattere Drive Mode – Yellow.

The alternative options are to have ambient lighting as White or completely OFF.

These can be selected from the right-side infotainment screen:

Select the  icon for the setup screen, then select “Vehicle” and finally select “Interior Lights” and select the desired option.



WINDSCREEN WIPER

The system has an adjustment range that varies progressively from wiper still (no stroke) when the windscreen is dry, to wiper at continuous speed (fast continuous operation) with intense rain.



- Pull the 1 button to activate the windshield washer.
- Press the 1 button to activate the wiper once.

As soon as the lever is pressed, a screen will open on the right HMI screen where the driver can select the following options for the speed of the windshield wiper:

- 1 OFF / ON
- 2 Speed 1 – slow interval
- 3 Speed 2 – fast interval
- 4 Speed 3 – low speed
- 5 Speed 4 – high speed
- 6 AUTO

If within 5 seconds, the driver does not select any option, the screen will close again, and the mode remains in AUTO. 5 seconds after the last interaction with the screen, the screen will close again as well.

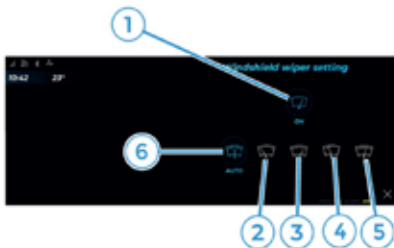

i *NOTE* If the driver's door is not fully closed, the vehicle will ignore the request to turn ON the windshield wipers. If the door becomes open while wipers are ON, the vehicle will turn OFF the wipers. Notification will be shown on the RIGHT LCD screen indicating- Door needs to be closed in order to turn on the wipers.

⚠ Do not operate the windshield wipers at speeds of above 200KM/h or 120MPH as their effectiveness will be reduced.

⚠ Do not operate the windscreen wiper with the blades lifted from the windscreen.

⚠ Fully clean any snow or ice build-up from the windscreen before switching the windscreen wipers on.

⚠ WARNING: If temperatures are below 4°C (40°F) use a windscreen washer fluid that contains anti-freeze (refer to "Fluids and lubricants" section in

“Technical data” chapter). Cold weather operation without anti-freeze could impact windscreen visibility. Some commercial additives for windscreen washer fluid are flammable.

ELECTRIC WINDOWS

The control buttons are located on the dashboard.

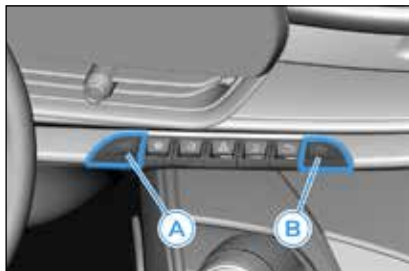

- A Front left window opening/closing button
- B Front right window opening/closing button

Window opening

Push buttons A or B to open the desired window.

Window buttons have 2 steps in the up and down positions.

Pressing the first step allows for manual rolling up/down of the window.

Pressing on the 2nd step allows for automatic rolling up/down.

Window closing

Lift the buttons to close the desired window.

The window closing stage occurs following the same logic described for the opening stage both front door windows.

Window anti-pinch safety device

The vehicle is equipped with an anti-pinch safety device for raising the windows.

This safety system can recognize the presence of obstacles when the window is closing. If detected, the system stops the window's movement and reverts it, depending on its position.

The anti-pinch safety function is activated both during the manual and the automatic operation of the window.

⚠ WARNING: *Incorrect use of the electric windows may be dangerous. Before and during the operation, always check that nobody is exposed to the risk of being injured either directly by the moving window or through objects getting caught or hit by it.*

LUGGAGE COMPARTMENT LIFTGATE

Press the open button 3 on electronic key for 3 seconds to allow access to the luggage compartment. Same button can close the luggage compartment liftgate by pressing and holding the button once more for 3 seconds. The liftgate is operated by 2 electric motors that allow for hands free operation of both closing and opening of the glass.

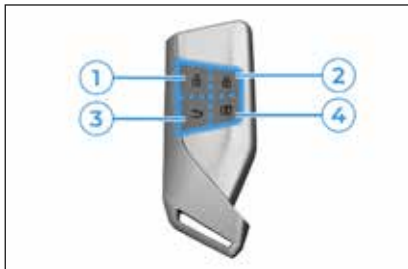

⚠ WARNING: Perform these operations only when the car is parked. Ensure that the area around the luggage compartment is free of obstacles before opening or closing. Ensure that the luggage compartment is fully closed before operating the vehicle.

Liftgate opening in case of electrical issue

The liftgate can be opened in case of electrical issues in the following manner:

- Through the right rear wheel arch, find the emergency release device of the liftgate accessible through opening 1.
- Remove the telescopic tool 2 from the cabin, in the seatback of the driver's side; extend it completely.
- Hook the telescopic tool 2 to ring 3 inside opening 1 and pull outwards to release the liftgate.

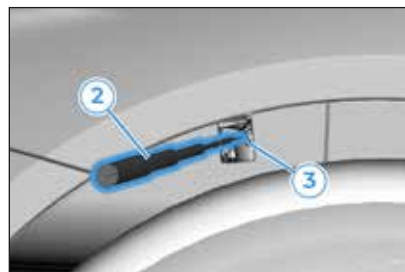

INTERIOR FITTINGS

USB connections

Battista comes with a total of 2 USB connections, for which one is in the center console near elbow 1 as well as in the glove box 2, both are Type A.

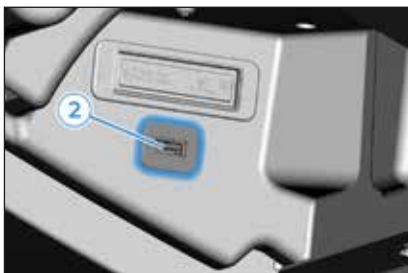

Ash Tray

In the center console to the right of the gear selector knob is a removable ash tray. It is covered by a lid that opens towards the passenger side of the vehicle. This ash tray also serves a purpose for storing the lighter (2) and cigar cutter (1). The lighter and cutter can be removed by simply pulling upwards on the desired item.

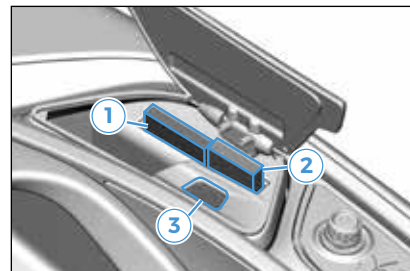
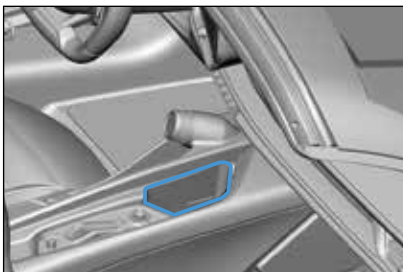

There is a designated place for inserting a lit cigar for continued smoking (3).

To clean the ashes out, the ash tray assembly can simply be lifted out vertically from the center console.

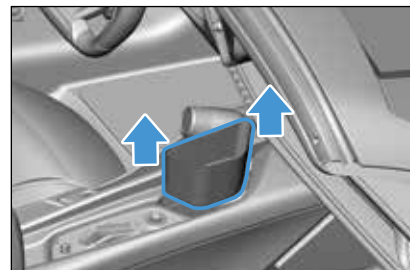

Cigar Storage

Located at the rear section of the center console, is a dedicated cigar holder which allows for storage of up to 3 cigars. The storage box has ambient lighting that changes with drive modes.

i NOTE: storage box does not contain any sort of climate control system for the cigars. Thus, the cigar storage box should be emptied out if vehicle is not in use for long periods of time to preserve the cigars.



To open the storage box, pull down on the leather strap 1 and fold open the compartment door to reveal the storage.

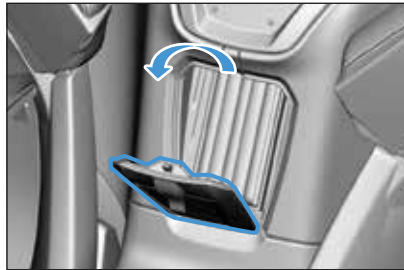
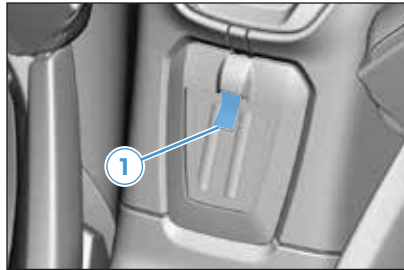

Once the compartment is open, the cigars can be removed from the individual slots.

To close the storage box, simply push on the door closed until an audible click is heard.

To clean out the storage compartment, pull out from the bottom of the cigar holder support. Installation of the compartment is in reverse order of removal, paying attention when inserting the holder into designated slots in the compartment 2.

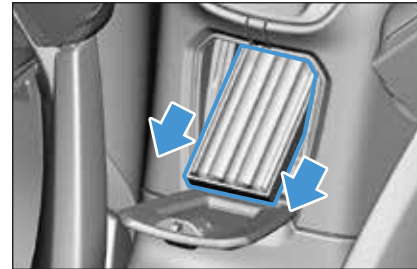



Glove box

Glove box is the interior compartment of the vehicle to store smaller objects safely and securely in the interior of the vehicle on the passenger side. It is illuminated and holds a USB type A port.

Glove box is opened via button 1 located in the interior of the vehicle, under the dashboard close to the knee. Glove box button when pressed releases the glove box latch if glove box is not locked.

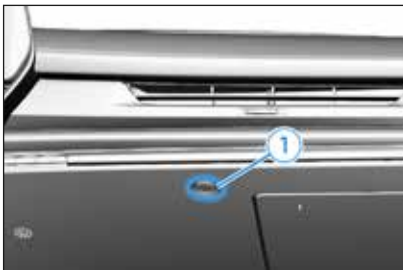

Glove box is equipped with a light source to provide additional visibility of interior compartment to the user. Light will turn on automatically when the glove box has been opened and will remain on for 30 seconds, after which it will turn off. If necessary, pressing the button again will further extend the duration of the glove box lighting another 30 seconds.

i **NOTE** The glove box is electronically operated, in case of power failure the glove box will not be able to open. The vehicle's owner's manual can also be found in your *Battista* mobile app.

⚠ WARNING: Do not travel with the storage compartment open: it may injure the front seat occupants in the event of an accident.

Fire extinguisher

A fire extinguisher 1 is located in the passenger compartment, in the footwell in front of the passenger's seat.



⚠ WARNING: Follow the proper inspection intervals for the fire extinguisher – if the inspection intervals are not followed, functionality is no longer guaranteed. Check the pressure gauge, if the yellow pointer is in the red zone, the extinguisher is inoperable. The extinguisher should be checked by an authorized specialist every 1-2 years to ensure proper operation.

⚠ WARNING: Follow the operating procedures on the fire extinguisher. Improper use could cause serious injury or damage.

i NOTE Not all countries require the vehicle to come equipped with the fire extinguisher, depending on the vehicle configuration your Battista may come with one.



STARTING AND DRIVING

GENERAL INFORMATION

Ground clearance

⚠ WARNING: *Damage to the underside of the vehicle may occur when approaching steep inclines or declines.*

Drive with care when:

- Approaching curbs.
- Approaching steep inclines.
- Departing steep declines.
- Driving on rough roads.
- Driving in areas where traffic speed bumps have been deployed.
- Driving in any other environment where sudden change of road surface height or elevation are encountered such as car parks.

Battista is a low ground clearance vehicle, familiarize yourself with the usage of the hydraulic lift

system described in detail in the contents of this manual. For information regarding the vehicle's dimensions including the ground clearance, please review chapter 9 of this manual for further information.

Track driving

Before any track driving, please contact your Automobili Pininfarina Partner to ensure a proper assessment of vehicle conditions is carried out.

Verify the following:

- Brake fluid not older than 24 months.
- Brake disks and pads wear > For any doubt please contact Service Partner.
- Tires wear & pressures > For any doubt please contact Service Partner.
- Rear wing functionality > refer to "Rear Spoiler" below in this chapter.

- Ride height and suspension static angles > For any doubt please contact Service Partner.

⚠ *Use only approved tires for Battista – refer to "Technical data" Chapter.*

⚠ *Always drive within your limits and the limits of the vehicle.*

⚠ WARNING: *Automobili Pininfarina recommends that you take time to cool the vehicle down during track driving, due to the high temperatures that may be generated by the brakes and propulsion systems which could affect performance. Time should be taken to drive the vehicle at a slower speed without using hard braking or accelerations, this uses the airflow to cool the vehicle. Allow that time for your vehicle to return to normal operating temperatures before leaving the track.*

GEAR SELECTOR KNOB



The gear selector knob is equipped with a rotary switch and a button. The center button is used to access functions of the vehicle like turning the powertrain ON and OFF, engaging and disengaging the Electronic Parking Brake (EPB).

Rotary switch provides the user with the user to select gear PRND- Park, Reverse, Neutral, Drive.

STARTING THE CAR AND DRIVING

To start the Battista the key must be inside the car so the system can detect it.

If the system does not detect a key, when you press the brake pedal, the display shows a message telling you the key is not inside.

If key is experiencing an issue, place the key in its cubby holder in the center console so the system can communicate with the key even if the key's internal battery is flat.



To start the car, proceed as follows:

- Fully Press the brake pedal
- Push the power switch 

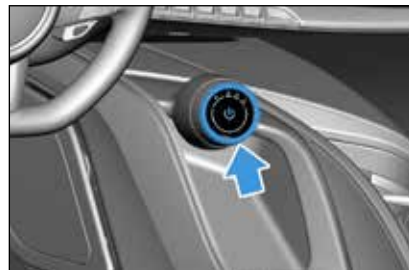

- After the telltales illuminate and perform their check, once all of them turn off, vehicle is “ready” for drive.
- Check the state of vehicle’s charge on the infotainment screen as well as the estimated range.
- Rotate the gear selector dial to the desired; forward (D) or (R) reverse gear.
- Release the brake pedal.
- Press the accelerator pedal and start driving.

When battery power is minimal, the display will show related

message and  icon.

If the low battery charge indicator illuminates yellow, the high voltage charge is too low for travel; please seek the nearest charging point.

i NOTE Limp mode icon will also illuminate when vehicle conditions limit its performance.

i NOTE Car is limited electronically to 350 km/h - maximum speed can be reached under ideal conditions.

PARKING THE VEHICLE

When stopping the vehicle, apply the brake pedal, then rotate the switch in the P (Park) position.

Push the power switch  to switch off the vehicle's propulsion systems.

⚠ WARNING: The vehicle could move and injure you or others around the vehicle if it is not in PARK. Check by attempting to move the transmission gear selector out of PARK with the brake pedal released. Ensure the powertrain is in PARK before you exit the vehicle.

⚠ WARNING: Bring the vehicle to a complete stop before shifting to PARK and ensure that the propulsion gear position indicator solidly indicates PARK (P) without blinking. Ensure that the vehicle is completely stopped, and the PARK position is properly indicated, before exiting the vehicle.

⚠ WARNING: Before exiting the vehicle, always make sure the ignition is in the OFF mode, remove the electronic key from the vehicle, and lock the vehicle.

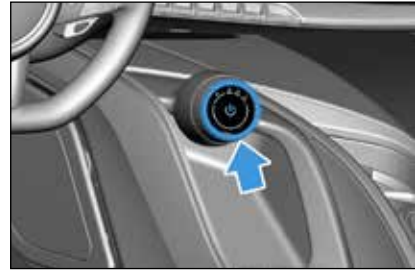



Electric parking brake

The car is equipped with electric parking brake to ensure better use and optimal performance compared to a manually operated parking brake.

The parking brake will automatically release the rear wheels once the gear selector knob is moved from Park and accelerator pedal is slightly applied, and as long as the driver's door is closed.

When put the switch into Park, parking brake is automatically

engaged and warning lights  **PARK** will appear on the instrument panel.

 **BRAKE** If the parking brake applied status light is flashing, the parking brake has failed to engage/ disengage. To resolve try to engage/disengage the parking brake again.

Emergency braking

This knob's center button is also used to engage the emergency brake system while driving. If emergency braking is needed, press and hold the button, the

parking brake light  **PARK** will start to flash and the gear will move to Neutral. Release the button to exit from the emergency brake function.

Holding the button will bring the vehicle to a complete stop, then the EPB will engage.

 *In the case of parking maneuvers on roads on a gradient, the front wheels must be steered towards the pavement (when parking downhill), or in the opposite direction if the vehicle is parked uphill.*

 **WARNING:** *If the parking is manually released, the vehicle may start to move.*

 **WARNING:** *The electric parking brake must always be engaged when leaving the vehicle. Do not leave the vehicle in NEUTRAL (N) as the vehicle will roll freely.*

GEAR SELECTION



Vehicle is equipped with an electric powertrain which transfers power directly to the wheels through 4 single-speed reduction drives, allowing for direct drive and instantaneous response

Gear Selector Dial

Direction of propulsion operation is controlled by the mode selector, which can have the following operating positions:

P = Park

R = Reverse

N = Neutral

D = Drive (forward speed with no gears).

P (Park)

Use this shift position when the vehicle is parked or when placing the vehicle in the READY to drive position.

i *NOTE to engage Park position, the car must be fully standstill.*

IMPORTANT Vehicle will ignore input if car driver selects park or reverse while driving in forward gear.

⚠ WARNING: *If the P (Park) position is not engaged, the vehicle could move and injure people. Before leaving the vehicle, make sure that the gear lever is in position P and that the vehicle has been powered off.*

D (Drive)

Use this position for all normal forward driving.

Passage from D to P (Park) or R (Reverse) modes must take place only after releasing the accelerator pedal, with car at a standstill and brake pedal pressed.

Reverse (R)

Select this mode only with the car at a standstill.

IMPORTANT Engage reverse only with the car stationary. Vehicle will ignore reverse if it is not fully stationary.

Whenever you select Reverse (R) on the mode selector, the right screen displays the view from the cameras (for details refer to “Rear backup camera” / “Surround view camera” section in this chapter).

N (Neutral)

Neither forward nor reverse gear is engaged.

The vehicle can be placed in the READY to drive position in this position.

Do not shift to the N (Neutral) position while driving. The regenerative brake system does not operate in the N (Neutral) position.

However, the vehicle brakes will still stop the car.

i *NOTE In emergency situations, for towing the vehicle, placing the gear selector knob to N (Neutral) will allow the vehicle to freely move allowing the tow operator to be able to move the vehicle without the parking brake applied.*

⚠ WARNING: *Do not leave the vehicle in Neutral on any kind of gradient unattended, as it can roll away causing potential injuries and or possible death.*

DRIVE MODE KNOB



Drive mode knob is located on the LEFT door near driver's knee and provides the user with the ability to change vehicle drive modes.

Drive Modes provide the user with the ability to custom tailor the vehicle to their specific driving style or needs. The driver is provided with four predefined vehicle settings that have been carefully set up for quick access. The fifth setting, Carattere, gives the driver freedom to select any of the available parameters and save it here.

DRIVE MODE SETTINGS

Driving Modes settings are available on the left display screen. There are four predefined drive modes available for the driver to select from, plus 1 additional custom mode called Carattere which are outlined below. Each mode offers a different, distinctive driving characteristic that varies in; agility level- acceleration and maximum power available, steering effort, suspension stiffness, regenerative braking-energy recuperation, safety system intervention in form of traction and stability control, intensity of the unique Battista sound.

i NOTE You are driving a vehicle capable of extreme performance, your safety and the safety of others sharing the road with you is paramount. Please drive in a safe manner and abide by all local driving laws.

To access the Drive Mode screens from the homepage page on the left screen, press button 1 to enter the different available drive modes. Swiping from left to right will allow you to go from one Driving Mode to the next.



i NOTE Each Drive Mode screen represents the available driving characteristics of that mode, and it will allow you to alter the Mode to your preference. The Drive Mode screen will not allow the driver to select the desired Mode, this must be done using the door mounted knob.

The following chart explains all the possible standard and optional characteristics of the four predefined driving modes.

System	Description	CALMA	PURA	ENERGICA	FURIOSA
Regeneration	Maximum efficiency	Default	Default	Optional	Optional
	Moderate deceleration	Optional	Optional	Default	Default
Steering	Standard– lighter effort	Default	Default	Optional	Optional
	Sport- higher effort	Optional	Optional	Default	Default
Suspension	Comfort – Soft setting	Default	Default	Not available	Not available
	Sport – Stiffer	Optional	Optional	Default	Optional
	Track - Stiffest	Not available	Not available	Optional	Default
Stability Controls – TCS and ESC	Standard – both TCS/ESC are on	Default	Default	Default	Not available
	Sport – reduced amount of intervention for TCS/ESC	Not available	Not available	Optional	Default
	OFF – track use only TCS/ESC	Not available	Not available	Not available	Optional
Sound	Low sound	Default	Not available	Not available	Not available
	Standard sound	Not available	Default	Not available	Not available
	Increased sound	Not available	Not available	Default	Not available
	Max sound	Not available	Not available	Not available	Default
Agility Level (Carattere only)	Max efficiency driving	Default	-	-	-
	Comfort driving	-	Optional	-	-
	Sportive driving	-	-	Optional	-
	Track driving	-	-	-	Optional

Calma



This drive mode is designed for efficient, energy-consumption optimized driving. This is the default driving mode when starting the vehicle.

Possible customizations are: Regenerative braking (High/Low), Steering (Standard/Sport), Suspension (Comfort/Sport)

i NOTE the vehicle will display actual performance attributes on the screen depending on the mode selected.

Pura



This is recommended for everyday driving with enhanced comfort focus. Also, it is recommended for driving in low adherence conditions.

Possible customizations are: Regenerative braking (High/Low), Steering (Standard/Sport), Suspension (Comfort/Sport)

Energica



This drive mode offers increased performance. Enhancing vehicle agility to provide the best possible driving experience.

Possible customizations are: Regenerative braking (Low/High), Steering (Sport/Standard), Suspension (Sport/Track), Stability Control (ON/Sport).

Furiosa



Drive mode is designed for driving on the racetrack in high grip conditions. Launch Control is available only in this mode, to obtain maximum performance.

Possible customizations are: Regenerative braking (Low/High), Steering (Sport/Standard), Suspension (Track/Sport) Stability Control (Sport/OFF).

⚠ WARNING: *Ensure that you are aware of the full performance potential that can be expected from your Battista at all times and in particular when using Furiosa mode.*

⚠ WARNING: *Do not initiate Furiosa mode unless on a track. Furiosa mode must not be used on any public road under any circumstances. Before initiating Furiosa mode ensure that the prevailing track conditions are suitable.*

⚠ WARNING: *When Furiosa mode is activated, the risk of the vehicle skidding, or the drive wheels spinning is increased. Adapt your driving style to account for this and to suit track conditions.*

Launch Mode

Launch mode is a specific optimization of the Furiosa Drive Mode, designed to provide maximum standing start performance.

⚠ WARNING: *It is advisable to lean your head against the headrest to prevent any strain on your neck from the high G forces during the launch.*

⚠ WARNING: *Verify that there are no loose items in the vehicle that could become projectiles during the launch.*

⚠ WARNING: *Verify that environmental conditions are adequate and verify your surroundings for space during launch control start.*

Launch Mode can only be activated when the following conditions are met:

- 1 Vehicle is stationary.
- 2 All occupants have their Seat Belts fastened.
- 3 Steering wheel 12 o'clock position, wheels pointing straight ahead.
- 4 Gear selected is Drive (D).
- 5 Drive mode selected is Furiosa.
- 6 All closures – such as doors, luggage compartment- are closed.
- 7 There are no errors present on the vehicle systems.

Press the brake pedal forcibly and then press the accelerator pedal all the way.

The left infotainment will display a check list that verifies the vehicle is ready for launch. If some of the above-mentioned conditions are not met, the recommended course of action will be shown on the same screen.

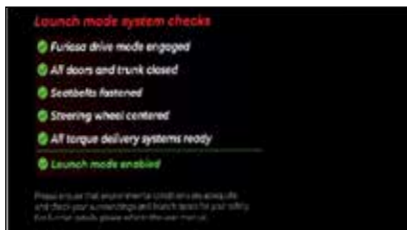

Upon successful systems check, launch mode will be enabled. A metallic-type sound will be heard, and the vehicle will inch forward as the preload torque is applied to the wheels.

If the check list does not show on the screen, there may be a problem with the vehicle not allowing Launch Mode to engage. Please check the notifications screen.

Fully Release the brake, while maintaining the accelerator pedal firmly planted against the floor – the vehicle will launch.

To exit the mode after successfully launching, simply apply the brakes or release the accelerator pedal.

Cancel launch mode sequence

Release of the accelerator pedal while holding the brake pedal will disable the Launch Mode.

i NOTE For safety reasons, it is advised not to operate Launch Control on public roads, in adverse weather conditions, poor pavement surfaces.

i NOTE For maximum acceleration performance, it's recommended that the battery state of charge is as high as possible, and its temperature is between 25-35 degrees Celsius. The efficiency of the launch mode will depend on external factors such as but not limited to surface type and tire temperatures

Carattere



Allows the driver to save and customize the different powertrain and chassis settings for a truly personalized driving experience to their driving profile.

The customization option will be based on the Agility Level that has been selected.

You will still be able to adjust temporarily: the recuperation, steering, chassis, stability controls, and sound options setting when Carattere is selected. When the vehicle is restarted the previously stored Carattere settings will be applied, and the temporary settings from the previous drive cycle will no longer be applied.

From each Driving Mode, specific characteristics and parameters can be altered by the user. These settings will remain until the vehicle is shut off unless they are saved to Carattere mode.

Once the selection has been made you can save or reset the setting touching the related buttons: RESET or SAVE TO CARATTERE.



i NOTE Some settings changes are only possible in certain drive modes, which will be highlighted with an additional symbol in drive mode screen.



Recuperation level: High/Low.



Suspension: Comfort/ Sport/ Track.



Steering: Standard/Sport



Agility Level: Range-Calma/ Comfort-Pura/Sport-Energica/ Track- Furiosa.



Sound Characteristic – 4 levels of intensity, based pre-existing drive modes.



Stability Level: Traction Control and Stability Control – allows for toggle between On/ Sport/Off depending on drive mode.

i NOTE Disabling of the traction control (TCS) and Electronic Stability Control System (ESC) is only possible in Furiosa mode.

To disable the Stability Controls, press and hold the Stability Level icon for 5 seconds a telltale will be



illuminated

⚠ WARNING: *Disabling of the TCS and ESC on public roads is not advisable and should only be done on the track by a skilled driver.*

Energy recuperation

Battista is designed to allow energy recuperation while driving and coasting or slowing down to a stop. Depending on the driving mode, the electric motor slows down the vehicle when the accelerator pedal is released, feeding energy back (recuperation) into the high-voltage battery and recharging it. The amount of recuperated energy increases to a maximum when the brake pedal is pressed. The maximum amount of regenerated energy can be temporarily reduced in certain situations.

For example, when the high-voltage battery is too cold to allow for maximum energy recuperation.

Each drive mode allows you to choose between two energy recuperation settings, one as default and one as optional – refer to table in Drive mode settings for more information.

The customization of this setting is possible via the following icon:



Recuperation level: High/Low

- HIGH – allows high recuperation and increased deceleration in throttle release.
- LOW – reduces the recuperation and drag according to throttle position.

In both cases the energy recuperation is maximized during braking.

Steering feel

Battista is equipped with electric power steering, which allows you to customize the steering feel according to driver's preference.

Each drive mode allows you to choose between two steering feel settings, one as default and one as optional – refer to table in Drive mode settings for more information. The customization of this setting is possible via the following icon:



Steering: Standard/Sport

- STANDARD – steering effort is lighter to accommodate more comfortable driving.
- SPORT – steering effort is higher to allow more sportive feeling in sporty driving.

Suspension

Battista is equipped with semi active dampers, which allows to customize the chassis damping according to driver's preference regarding road inputs and dynamic load transfer.

Each drive mode allows you to choose between two chassis settings, one as default and one as optional – refer to table in Drive mode settings for more information. The customization of this setting is possible via the following icon:



Suspension: Comfort/ Sport/ Track.

- Comfort – damping is lower to accommodate more comfortable driving.
- Sport – damping is set to firmer setting to accommodate more spirited driving.
- Track – damping is further enhanced from Sport tailored to smooth track surfaces.

Stability controls

Battista is equipped with stability controls to reduce the risk of accidents owing to an inappropriate driving speed. The main controls acting are Traction Control System (TCS) and Electronic Stability Control (ESC). The increased safety provided by both systems should not induce you to take greater risks with your safety. The physical driving limits can still be surpassed, even with these systems enabled, therefore the driver remains responsible for adapting the driving style and maneuvers to the road and weather conditions, as well as the traffic situation.



Stability Level: Traction Control and Stability Control

- DEFAULT - all stability and traction control functions are on, there is no telltale on the screen.
- SPORT - allows for increased level of tire slip.

ESC
SPORT

will be illuminated.

- OFF - all safety stabilization and traction control systems are turned off – **for track use ONLY.**

ESC
OFF

will be illuminated.

Drive modes customization on the stability controls is allowed only in Energica, Furiosa and Carattere according to table in Drive mode settings. For more details on the TCS and ESC, please refer to “Driving safety system” section in this chapter.

Torque vectoring

Battista is equipped with a Torque Vectoring system, which allows you to find the optimal torque split across the four electric motors to enhance the vehicle trajectory.

The system is based on the analysis and forecast of vehicle performance in all possible conditions. The input signals are the dynamic parameters of the vehicle that the control system uses to optimize the torque distribution. In a curve, the Torque Vectoring enhances and optimizes the lateral grip limit and agility of the vehicle in high dynamic conditions.

Torque Vectoring setting is automatically defined for each drive mode and cannot be customized by the driver.

LIMP MODE

Battista will set itself into Limp Mode in case of a problem that still allows for limited-performance driving conditions, this will allow the driver to easily pull off the road in order to seek assistance. Limp Mode is designed to allow the driver to come to a safe complete stop. Limp Mode is not a driving mode. The activation of the Limp Mode is indicated by the switching on

of a warning light  on the left infotainment screen.

Limp mode will also activate when the battery state of charge reaches low percentage, to preserve enough energy to allow for drive.

The performance of your vehicle will be greatly reduced for safety. Please contact your Automobili Pininfarina Service Partner who will be able to assist you.

 **WARNING:** *Attempting to further drive the vehicle with the Limp Mode enabled, may further damage the vehicle.*

TOW MODE

In case of a vehicle breakdown, the vehicle must be able to be recovered by an approved recovery provider using a flat-bed truck. When the vehicle is parked, the rear wheels are held locked via means of an electronic parking brake system and the electric motors are locked. The wheels and motors must be “Free Rolling” in order to be able to winch the vehicle onto the flat bed.

Depending on the angle of the recovery truck, it may be required to activate the vehicle lifting system (refer to “Lift function” in this chapter).

 **WARNING:** *When “Tow Mode” is enabled, the vehicle will be free rolling, thus utmost care must be taken. Failure to properly secure vehicle while free rolling can result in property damage and/or personal injury risks even death. Always make sure the vehicle is secure from rolling freely.*

Enabling Tow Mode: With the vehicle powered on and engaged, but disengaged state (i.e. visible by speedometer shown on center screen) and driver's door open or closed, press on the brake pedal firmly and while holding the brake pedal press and hold the Power Button on the PRND knob for approximately 12 seconds. There will be an audible chime and audible motor like noise from the exterior rear of the vehicle, which is the sound of the electronic parking brake calipers releasing. In addition to that confirmation of the activation of the Tow Mode will be shown on the center infotainment screen.

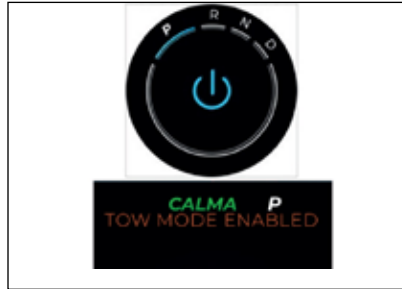

Disabling Tow Mode: with the vehicle powered on (i.e. visible by having the infotainment screens on), press the power button once. The electronic parking brake will be heard engaging and the notification about the Tow Mode Enabled on the center screen will no longer be shown. Vehicle will return to the vehicle awake but not engaged mode.

VALET MODE

Valet mode can limit the performance and turn off certain functions of the vehicle. It can be set via the infotainment screen – see icon 1 below, for the vehicle using a specially assigned-by user, pin. Vehicle's top speed will be limited to 50km/h or 31mph. Its maximum power will be limited, and drive mode will be set to Calma with no ability to change it. Traction control and Stability control will always be set to on, and glove box and trunk compartment will be locked. Additionally, to preserve the user's privacy, the navigation system nor the media player be available while the Valet Mode is enabled.

i **NOTE:** while the vehicle will not have connected services available – it will still be connected to the user's mobile app where it can be remotely monitored.



DRIVING SAFETY SYSTEM

ABS (Anti-lock Braking System)

This system, which is an integral part of the braking system, prevents one or more wheels from locking and slipping in all road surface conditions, irrespective of the intensity of the braking action, ensuring that the vehicle can be controlled even during emergency braking and optimizing stopping distances.

The system intervenes during braking when the wheels are about to lock, typically in emergency braking or low-grip conditions, when locking may be more frequent.

The system also improves control and stability of the vehicle when braking on a surface where the grip of the left and right wheels varies, or on corners.

⚠ WARNING: If the ABS intervenes, this indicates that the grip of the tires on the road is nearing its limit: you must slow down to a speed compatible with the available grip.

⚠ WARNING: The ABS cannot overrule the natural laws of physics and cannot increase the grip available according to the condition of the road.

⚠ WARNING: The ABS cannot prevent accidents, including those due to excessive speed on corners, driving on low-grip surfaces or aquaplaning.

⚠ WARNING: The capability of the ABS must never be tested irresponsibly and/or dangerously, in such a way as to compromise personal safety and the safety of others.

⚠ WARNING: For the correct operation of the ABS, the tires must be in perfect condition and, above all, of the prescribed type, dimensions, and pressure.

Electronic stability control (ESC)

ESC monitors driving stability and traction between the tires and the road surface.

ESC detects when a wheel starts to spin, or the vehicle starts to skid and stabilizes the vehicle by braking individual wheels, and/or limiting the engine power output. This also assists when pulling away on wet or slippery road surfaces and stabilizes the vehicle when braking.

i NOTE ESC only functions properly if wheels with the recommended specification tires are used. ESC is activated automatically as soon as the vehicle enters Powertrain State.

⚠ WARNING: If the ESC warning illuminates, do not deactivate electronic stability control. Adapt your driving style to suit road and traffic conditions.

Traction control system (TCS)

TCS modulates the electric motors torque to prevent the wheels from spinning and allow appropriate traction in dynamic conditions and slippery surfaces.

⚠ WARNING: The TCS cannot reduce the risk of an accident if you drive too fast.

⚠ WARNING: TCS can be disabled only through disabling Stability Controls in Furiosa.

Deactivating stability controls (ESC & TCS)

⚠ WARNING: When stability controls are deactivated, the risk of the vehicle skidding is increased. Adapt your driving style to suit road and traffic conditions.

⚠ WARNING: Do not deactivate stability control unless on a track and prevailing conditions are suitable.

i NOTE When you deactivate stability control, the following conditions result:

- The **ESC OFF** and  warning light illuminates.
- ESC and TCS no longer improve driving stability.
- The electric motors torque is no longer limited, and the drive wheels could spin.
- The ABS remains activated.

Stability controls dynamic modes

The level of stability control can be toggled between three dynamic modes to suit the driver's requirements and is dependent on the Drive Mode currently active. The stability Controls icon allows you to change both ESC and TCS setting at the same time to find the best driving setup.

It is possible to change stability controls settings only in Energica and Furiosa, while in Pura and Calma only default setting is available. The setting can be selected at any vehicle speed.

Stability controls – maximum stability

The stability control is ON by default in all modes. The maximum stability setting is the default setting in Calma, Pura and Energica and Carattere (if proper agility level is selected).



Stability Controls (TCS & ESC) – Sport

The Stability Controls Sport setting is intended to allow more sportive driving while still being active. This setting is optional in Energica and default in Furiosa.

When Stability Controls setting is in Sport, the corresponding

telltale will be turned on 

To enable Stability Controls SPORT

- 1 Select Energica mode.
- 2 Press  button to access the menu
- 3 Choose sport setting and confirm
- 4  warning lamp will be displayed.

Stability Controls (TCS & ESC) – OFF

Stability Controls can be disabled only in Furiosa Mode. The driver shall observe all the warnings mentioned in the previous section. To disable Stability Controls

- 1 Select Furiosa mode.
- 2 Press  button to access the menu.
- 3 Press and hold the ESC OFF button for 5 seconds, to deactivate the Electronic Stability and Traction Controls.
- 4 ESC OFF warning lamp will be

 displayed.

While in Furiosa, to re-enable stability, press the Stability Controls button.

ESC will be always automatically re-enabled according to table in Drive mode settings if drive mode is changed from Furiosa to others drive modes or at every vehicle restart.

CREEP MODE

The creep function allows the vehicle to drive away automatically from a standstill when the brake pedal is released if drive position D is selected.

The vehicle moves (creeps) when the Drive position is engaged. In some situations, such as on a steep hill or driveway, you may need to press the accelerator pedal to continue moving or to prevent the car from moving in the opposite direction.



⚠ WARNING: *Never rely on CREEP to apply enough torque to prevent your vehicle from rolling down a hill. Always press the brake pedal to remain stopped or the accelerator pedal to proceed up the hill. Failure to do so can result in property damage and/or a collision.*

The creep functionality can be enabled or disabled by the driver by pressing the icon 1. The system will keep the memory of the latest setting.

AUTOMATIC VEHICLE HOLD (AVH)

The AVH function assists the driver when stopping and driving off on slopes. The vehicle is automatically prevented from rolling away from the desired direction of travel.

When the AVH function is active,

the indicator light  on the instrument cluster comes on.

To disengage the AVH, just gently press the accelerator pedal.

⚠ WARNING: *Despite the AVH function, responsibility for stopping and starting on gradients lies with the driver. When stopping and starting on slippery surfaces, e.g., icy, or loose substrate, the AVH function cannot be guaranteed to provide assistance. The vehicle can roll away, therefore always adjust your driving style to the road slope and surface and to the vehicle load; use the footbrake if necessary.*

⚠ WARNING: *Slight rolling back on uphill slopes. If the vehicle comes to a standstill on steep gradients without the driver applying the footbrake, the vehicle can roll back until the AVH function stops it.*

In this situation it is possible to reduce the roll-back by applying the footbrake and increase the braking force with the footbrake to support stopping.

To activate the AVH function drive in D or R and press the brake pedal until the vehicle comes to a standstill. The AVH function is activated if the brake pedal is sufficiently pressed when the vehicle comes to a standstill. Once activated, the vehicle is held stationary even without pressing the brake pedal. A telltale icon



will be displayed on the infotainment screen indicating the AVH is active.

⚠ WARNING: *Always be aware of the AVH engagement by*

making sure the telltale  on the left screen is illuminated indicating the system being active. Failure to do so may result in the car rolling and even potential damage to your vehicle and its surroundings. It is your responsibility as the driver to make sure that you are in control of the vehicle.

⚠ *The AVH function can also be activated, irrespective of the gradient, by firmly pressing the brake pedal while the vehicle is already stopped.*

REAR SPOILER

The rear spoiler, which also acts as an airbrake, is located at the rear of your car.

⚠ *When the Battista is turned ON the rear spoiler performs a self-test of the hydraulic system and may make some noise that is noticeable to the driver. Unlike other systems out there, the noise of the spoiler Mechanism is amplified due to the lack of an internal combustion engine.*

To manually operate the rear spoiler, proceed as follows:

- Pull up and hold the switch 1 to raise the wing to its full position.
- Let go of switch 1 to lower it fully.

i **NOTE** *Manual rear spoiler operation is only possible while at speed of less than 5KM/h or 3MPH, or if fully stopped:*

⚠ WARNING: During manual operation of the rear airbrake/spoiler, always be aware of your surroundings to ensure no object or being is in the close vicinity of the rear spoiler mechanism. Severe injury or damage can occur.

i NOTE Battista has two high mounted stop lights, one is at the top of the rear glass and the other is mounted on the bottom center of the spoiler. When the aero brake is activated, the top brake light is obstructed, and this is the reason for the bottom mounted one.

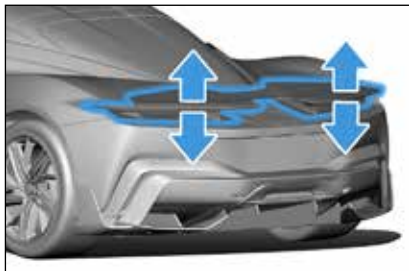

i NOTE In case of a rear spoiler malfunction, the vehicle will derate its performance and notify the driver of the issue via the alerts section of the left display screen - it will also instruct to drive the vehicle at reduced speeds and to seek repairs at your Automobili Pininfarina Service Partner.

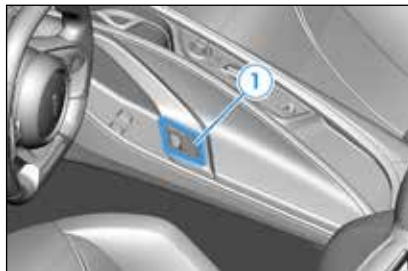

BRAKES

⚠ WARNING: Do not keep any objects in the driver's footwell. Ensure that floor mats or carpets are properly secured and do not obstruct the pedals.

If objects become trapped between the pedals, you may not be able to brake or accelerate, and this could lead to an accident.

⚠ WARNING: If the brake warning light illuminates while the vehicle is in motion, stop the vehicle as soon as safety permits and contact your Automobili Pininfarina retailer immediately.

The vehicle is equipped with an Electronic Brake Booster. In case of failure, a much greater force must be applied to the pedal when braking.

⚠ WARNING: Do not rest your foot on the brake pedal while travelling as this may overheat the brakes, reduce their efficiency, and cause excessive wear.

Brake discs and pads

The car's braking system consists of four carbon-ceramic disc brakes.

⚠ WARNING: *New brake pads require a period of bedding in. For the first 400 km, avoid situations where heavy braking is required.*

Brake disc and pad wear depends on the driving style and driving conditions. The vehicle is equipped with brake pads wear sensors that help to monitor the pads wear. If pad thickness reduces to an acceptable limit, a warning lamp will be lit, and a brake system check is recommended at the earliest possible time to preserve parts integrity.

⚠ *Given the high technological level that characterizes this system, for any intervention it is strongly advisable to contact an Automobili Pininfarina Service Partner which can guarantee the level of competence necessary in repair work.*

⚠ WARNING: *The carbon-ceramic materials used, and the structural characteristics of the system could generate abnormal noises in some environmental circumstances, which should not be considered a malfunction and in any case do not affect the correct functioning and reliability of the braking system. Some vibration may be felt from the brakes in the steering wheel on initial brake pedal application after system is exposed to high temperature as effect of thermal recovery.*

⚠ WARNING: *After high-intensity usage of the car do not touch the disk brakes to avoid burnt fingers. If necessary, use protective gloves.*

⚠ *The presence of condensation or salt deposits on the braking surfaces, for example after washing the car or after an extended period of inactivity, may make it necessary to apply a higher pressure on the brake pedal for the first reuse to*

guarantee the same braking capacity.

⚠ *Before and after any intense or performance use of the car, have the functionality and condition of the carbon ceramic brake system checked.*

Brake temperature monitoring

The vehicle is equipped with a brake temperature monitoring system, which is intended to notify the driver with information in the event of high temperatures predicted in the braking system.

⚠ *The system is intended to aid during high performance driving, however it is recommended to perform a cooldown session before stopping the vehicle completely, unless necessary, as the brakes cool more effectively while the vehicle is in motion.*

If the brake system detects high temperature, a warning message will be shown on the touchscreen to inform the driver.

If the driver does not acknowledge the warning and does not perform a cooldown phase, the vehicle will apply a limitation of available acceleration performance to the driver until the brake temperature has been sufficiently reduced. Once the brake temperature is within the safe system limits, full vehicle power will once again be at the driver's disposal.

G-FORCE METER / PERFORMANCE OVERVIEW / TRIP PERFORMANCE

These types of information are available on the related screen of the left display. Press icon 1 to enter the menu, swiping on the touchscreen you can switch in order the following screen:

- G-Force meter.
- Performance overview
- Trip performance



Trip performance

The Trip performance screen can be used to display the values related to the car's operating state. Trip performance allows you to see the values shown on the screen below.

In trip screen is available RESET button: it allows you to reset all values to begin a new journey.

i NOTE images shown below are for demonstration purposes only, they do not represent the capabilities of the vehicle. Always obey the rules of the road:



G-Force meter

G-Force meter screen displays a graphic with the direction of acceleration.

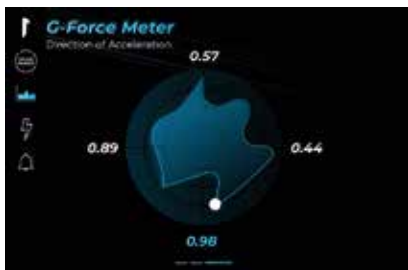

Performance overview

Performance overview screen displays a graphic with the temperature and pressure values associated with each tire and the battery temperature and a list of values about torque, output power, speed, and other parameters.



CRUISE CONTROL

⚠ WARNING: *The system is an aid for the driver, who must always pay full attention while driving. The responsibility always rests with the driver, who must consider traffic, road, and weather conditions to drive in complete safety. The driver must always maintain a safe distance from the vehicle in front.*

⚠ WARNING: *The system cannot take account of road, traffic and weather conditions, and conditions of poor visibility (e.g., fog). Do not use cruise control during inclement weather, during periods of heavy traffic, or on winding roads.*

⚠ WARNING: *Pay the utmost attention while driving at all times and be always ready to press the brakes if needed.*

⚠ WARNING: *If you are going downhill with cruise control on, your vehicle's speed may increase above the speed you have set. The system will not apply the brakes.*

⚠ WARNING: *Be sure to pay attention to changing road conditions when using cruise control - such as roads with intersections or roundabouts, roads without visible lanes of travel, roads that are winding, slippery, unpaved, or steep slopes. Using cruise control in these situations can be dangerous and could result in loss of control of the vehicle.*

Cruise Control is an electronically controlled driving assistance system that allows the desired car speed to be maintained, without having to press the accelerator pedal.

This device can be used at a speed above 30km/h on long stretches of dry, straight roads with few variations (e.g., motorways).

It is therefore not recommended to use this device on extra-urban roads with traffic.

Do not use the device in town.



Activation / Deactivation

To enable the device, with current speed between 30km/h and 250km/h, press and release the



button on the steering wheel.

With device active, to deactivate it press and release the same button.

When cruise is SET, the middle display on top of the steering column will show a green telltale



and the currently set speed.



When your current speed is lower than 30km/h or above 250km/h and you request to activate Cruise Control, a speed limit notification appears on the center info display. The system will be automatically deactivated by pushing the brake pedal.

Setting the desired speed

Speeds from 30km/h to 250km/h can be set.

When the car reaches the speed desired, press and release the + or - button on the steering wheel for set speed to speed current: the display will show set speed. Then lift the foot from the accelerator pedal. When the accelerator is released, the vehicle will keep the selected speed automatically.

Speed increase

Once the system has been activated, you can increase the speed by gently pressing the + button. Each time it is operated, the speed increases by 2km/h. Pressing + button with slightly longer will allow speed increase by speed 10km/h until button is released, then the new speed will be stored.

If needed (when overtaking for instance), you can accelerate simply by pressing the accelerator; when you release the pedal, the vehicle goes back to the speed stored previously.

Decreasing speed

Once the system has been activated, you can decrease the speed by gently pressing the - button. Each time it is operated, the speed decreases by 2km/h. Pressing - button slightly longer, the set speed will decrease in steps of 10km/h / sec until the button is released, then the new speed will be stored.

LIFT FUNCTION



Battista has a hydraulic lift suspension system which is used for raising the front and rear end of the car when entering steep driveway or going over speed hump/bumps.

To activate the lift function, press the control button  on the steering wheel.

The suspension can be left fully raised for extended periods, but it may relax to a lower level over time.

Notifications on the screen indicate when the vehicle is in lowering or raising motion for the

duration of the procedure and when the operation has been completed, the screens will inform the user about it. A warning light



switches on to indicate the suspension lift/lowering is currently enabled. In the occasion of a system malfunction, the

warning light  will indicate it.

⚠ WARNING: Do not park the vehicle over any surfaces with the hydraulic system engaged – shutting down the vehicle will cause the vehicle to lower. This can cause damage to the vehicle and potentially cause damage to its surroundings.

⚠ WARNING: Do not place any objects under the vehicle after it's been lifted using the hydraulic lift system, as the system will lower the vehicle upon powering down

Vehicle ride height can only be raised when travelling at speeds below 40km/h.

The vehicle will automatically lower at speeds above 40km/h.

If vehicle lift is used when in motion, slight adjustments to the steering feel may be experienced, this is normal and does not affect the operation of the vehicle.

⚠ WARNING: The lift system should never be used as a jacking system. Using the lift system to access the undercarriage of the vehicle could result in severe injury. Do not place anything or body parts under the vehicle while it is in the lifted position.



PARK SENSORS SYSTEM

The ultrasonic parking sensors, located in the front and rear bumper, detect the presence of any obstacles, and warn the driver about them, through an acoustic signal and, where provided, visual indications on the right display.

System activation/ deactivation

The system, when engaged, is automatically activated by selecting the reverse (R) or drive (D) gear, while it is deactivated by selecting another position of mode selector.

When gear is engaged and there is an obstacle behind or in front of the car, an acoustic signal with variable frequency is activated: increases as the distance between the vehicle and the obstacle decreases; becomes continuous when the distance between the vehicle and the obstacle is less than 30 cm (1ft) and stops if the distance

increases; is constant if the distance between the vehicle and the obstacle is unchanged.

i **NOTE** the system only functions at lower speeds. It can sense objects up to 1.5 meters (5ft) away from the vehicle.

⚠ **WARNING:** You are responsible for always controlling your vehicle, always use caution when in reverse gear and when using the parking sensor system. Always check to ensure that the area around the vehicle is free of obstructions. Check outside mirrors and glance over your shoulder before reversing, when making lane changes, or merging. Never depend solely on the parking sensor to detect objects that could potentially cause injury or damage, use your own eyes and side mirrors. The parking sensor system is not designed as a substitute for responsible driving.

⚠ **WARNING:** The parking sensor system may not operate as expected during inclement weather conditions, for example during heavy snow or rain, ice, or spray. Always drive with due care and attention. Failure to take care may result in a collision.

⚠ **WARNING:** Some situations and objects could prevent hazard detection by the parking sensor system. For example, harsh sunlight, low light, or inclement weather. Always be ready to apply the brakes when necessary. Failure to take care may result in a collision.

⚠ **WARNING:** Do not use the parking sensor system with accessories that extend beyond the front or rear of your vehicle. The parking sensor system is not able to make corrections for the additional length of any added accessories.

⚠ **WARNING:** Parking and other potentially dangerous maneuvers are, however, always the driver's responsibility. When performing these operations, always make sure that there are no other people (Especially children) or animals on the route you want to take. The parking sensors are an aid for the driver, but the driver must never allow their attention to lapse during potentially dangerous maneuvers, even those executed at low speeds.

⚠ The sensors must be clean of mud, dirt, snow, or ice for the system to operate correctly. Be careful not to scratch or damage the sensors while cleaning them. Avoid using dry, rough, or hard cloth. The sensors should be washed using clean water with the addition of car shampoo if necessary. When using special washing equipment such as high-pressure jets or steam cleaning, clean the sensors very quickly keeping the jet more than 10 cm away.

VIEW CAMERAS

Rear back-up camera

The car is equipped with two rear cameras located above the rear license plate, as shown in the figure.

One camera is dedicated for rear view mirror function, second camera is dedicated for rear view function displayed on the infotainment screen

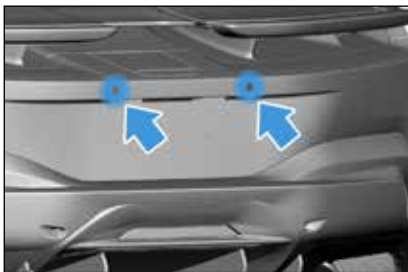

Whenever you select Reverse (R) on the mode selector, the Right Screen displays the view from the camera.

Lines show your driving path based on the position of the steering wheel. These lines adjust appropriately as you move the steering wheel.

Surround view camera

The Surround View Camera increases the level of safety when you are parking, making every manoeuvring procedure easier, smoother, and less stressful.

The Surround View Camera assists you during parking maneuvers by combining all the information provided by cameras that will give you a broad view of the area around your car.

In all situations where it is hard to see and assess the distance between you and already parked cars, the system also provides dynamic gridlines to show your predicted trajectory. All information gathered from the parking sensors will also help you by alerting you to otherwise hidden obstacles.

When gear selection dial is shifted to R (Reverse) position, the rear view of the surrounding scenario will be automatically displayed on the screen. User can select an alternative view by clicking on one of the 4 available cameras: 1 front view, 2 rear view, 3 left and 4 right views.



Please note the system will not contain a bird's eye view or top view. It does not provide a complete 360-degree view around the vehicle.

The screen will allow you to turn off the sound notifications for the parking sensors, allow you to tilt down the mirrors and allow for zoom.

System can also be enabled with speeds up to 16km/h or 10MPH while driving in a forward direction by tapping the camera icon 1 on the left main landing screen



The camera feed will then be projected on the right screen, where the view can be toggled between each camera. If the speed exceeds 16km/h or 10MPH, the camera will not be selectable and a message indicating exceeded speed will appear.

⚠ WARNING: Always check to ensure that the area around the vehicle is free of obstructions. Check outside mirrors and glance over your shoulder before reversing, when making lane changes, or merging. Never depend solely on the camera to detect objects that could potentially cause injury or damage, use your own eyes and side mirrors. Objects may appear closer in the Full LCD Interior Mirror than they are. The rear-view camera is not designed as a substitute for responsible driving.

⚠ WARNING: Parking and other potentially dangerous maneuvers are, however, always the driver's responsibility. While carrying out these maneuvers, always make sure that no people (especially children) or animals or any other obstacles are in the area concerned. The camera is an aid for the driver, but the driver must never allow his/her attention to lapse during potentially dangerous maneuvers, even those executed at low speeds. Always keep a slow speed, to promptly brake in the case of obstacles.

⚠ It is vital, for correct operation, that the camera is always kept clean and free from any mud, dirt, snow, or ice. Be careful not to scratch or damage the camera while cleaning it. Avoid using dry, rough, or hard cloths.

⚠ WARNING: *The view camera system is designed to function properly during the day or under good lighting conditions. You must never rely on the system only under poor lighting conditions.*

⚠ WARNING: *The distance and trajectory lines must always be interpreted only as a reference and only when the vehicle is on flat ground.*

⚠ *Vehicle's cameras may not project complete surrounding of 360-degree angle around the vehicle.*

GETTING MAXIMUM RANGE

The distance you can drive the vehicle (range) can vary depending on several factors:

- Speed,
- Electrical load from vehicle accessories,
- Traffic and road conditions,
- Distance driven without stopping,
- Usage,
- Driving style,
- Battery age,
- Weather or temperature,
- Uphill travel,
- Charging habits.

To achieve maximum range:

- Drive in CALMA Drive Mode (refer to “Drive mode settings” in this chapter). This mode helps reduce power consumption by enabling gentler and more efficient acceleration thanks to an optimized accelerator pedal map.
- Avoid great variations of speed induced by strong accelerations and hard braking.
- Drive at moderate speeds on the highway.
- Avoid frequent stopping and braking. Maintain a safe distance behind other vehicles.
- Turn off the air conditioner/heater when it is not necessary.
- Select a moderate temperature setting for heating or cooling to help reduce power consumption. Use of seat heater is recommended over cabin heater to achieve a comfortable driving environment.

- Use the air conditioner/heater and close windows to reduce drag when cruising at highway speed.
- Vehicle range may be substantially reduced in extremely cold weather. Hence ensure the vehicle is stored in a warm space before you set off to drive, in cold weather conditions, especially overnight.
- Precondition the car while it is plugged in to ensure the cabin is at a comfortable temperature and windows are defrosted (if needed) before your drive.
- Release the accelerator pedal to slow down and do not apply the brakes when traffic and road conditions allow. This vehicle is equipped with a regenerative brake system. The primary purpose of the regenerative brake system is to provide some power to recharge the High Voltage battery and extend driving range. In the D (Drive) position, when the accelerator is released, the regenerative

brake system provides some deceleration and some power to the Li-ion battery.

- Keep tires inflated to correct pressure (refer to “Rims and wheel” section in “Technical data” chapter). Keep wheels in correct alignment.

TIRE SELECTION

In order for Battista to perform optimally, the correct tire must be selected from the vehicle settings menu. The electronically controlled vehicle dynamics and traction systems have been optimized to attain maximum performance possible, for each specific tire fitment.

i NOTE: *Always, make sure that the right selection is chosen for the tire on the vehicle and make changes while stationary.*

- Michelin Pilot Sport Cup 2 R – Road legal semi slick tire optimized for extreme dry performance on racetracks.
- Michelin Pilot Sport Cup 2 – Semi slick tire optimized for ultra-high performance on racetrack and road.

- Michelin Pilot Sport 4 S – High performance summer tire with excellent capability in wet conditions.
- Pirelli P Zero™ Winter – Tire fitment for the winter season.

From the right-side screen:

Select the  icon for the setup screen, then select “Vehicle” and finally select “Tire Type” from the available choices.





CHARGING

The BATTISTA requires to be charged with electricity to operate. The 800V High Voltage battery allows up to 120kWh of total stored energy as new.

It is crucial that the Customer avoids completely discharging the Li-Ion battery, as it would render the vehicle unable to be driven and could even lead to permanent limitations on the High Voltage battery performances.

As such, it is recommended that the Driver pays attention to the State of Charge (SOC) during driving and plans adequately for charging stops at compatible charging stations.

BATTISTA is equipped with advanced charge optimization algorithms that will try to optimize the time to completely charge the battery, based on parameters such as the system temperature, condition and age, its current State

of Charge, the type of charging station, but also additional comfort functions that may be active (Cabin Air Conditioning, heated seats...).

On alternating current chargers (AC chargers), commonly found in domestic installations, hotel garages and street-side, BATTISTA can charge at the following maximum rates:

- On single-phase installations in Europe and China: up to 4.6kW.
- On single-phase installations in the USA (110V): up to 2.2kW
- On three-phase installations in Europe and China: up to 22kW
- On split phase installations in the USA: up to 4.8kW

It is important to note that the charging rate cannot exceed the rating of the charger itself, or of the cable being used between the charger and the vehicle. Using a three-phase installation

in Europe, it is therefore possible to completely recharge BATTISTA in less than 7 hours, therefore this type of installation is recommended for overnight slow charge, or intra-day charge top-up.

On compatible direct current chargers (DC chargers), commonly found on motorways and highways, or on intercity roads that are of 800+ Volts.

The peak DC charging power will always occur at lower States of Charge, and if the vehicle is in an ideal temperature range. As such, spirited driving before a DC “Fast Charge” may place the battery in a suboptimal temperature range, and the peak charging power may not be achieved.

In ideal circumstances, BATTISTA can be recharged from 20-80% in approximately 25 minutes.

For longer periods of time storing the vehicle, it is recommended to keep the main traction battery at 80% state of charge.

BATTISTA is also capable of using the charger power supply to perform other operations, such as conditioning the battery and cabin to optimal temperatures. It is therefore recommended to the Customer, especially during long periods and/or colder periods, long term storage - refer to Car inactivity (Long Term Storage) section in “Maintenance” chapter to leave the car plugged in. This should guarantee ideal drive-off conditions and a ready-to-go battery.

ELECTRIC VEHICLE COMPONENTS

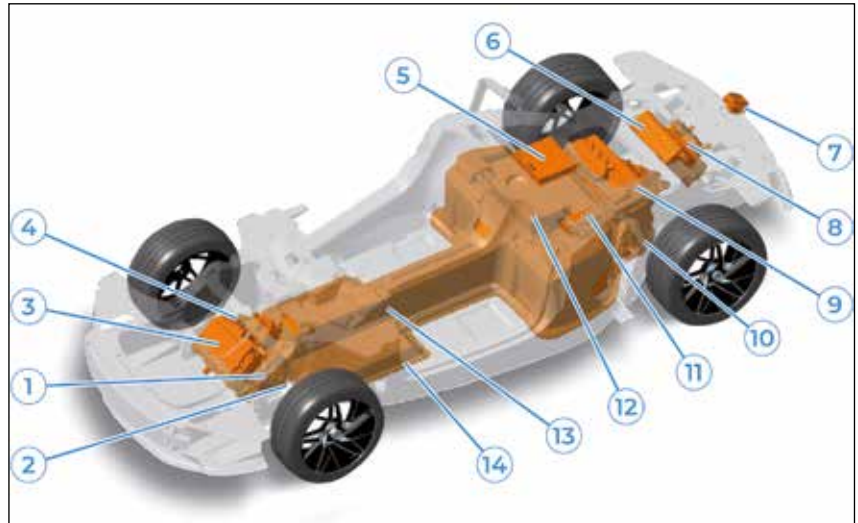

- | | |
|-------------------------|---|
| 1 Front motors | 9 Rear inverter |
| 2 Cabin heater | 10 Rear motors |
| 3 Front inverter | 11 Battery heater |
| 4 HVAC AC compressor | 12 PDU |
| 5 DC/DC converter | 13 HV battery |
| 6 HV battery charger | 14 Vehicle HV service switch ON/
OFF |
| 7 Charging inlet | |
| 8 Battery AC compressor | |

⚠ WARNING: Short circuits, shock, explosions, fire, and severe burns could result from not charging the battery correctly. This could lead to serious and fatal injuries.

⚠ WARNING: Only charge at sockets that are correctly installed, that have been properly tested, and that are not damaged. Always have the charging equipment with you that is required for the country you are driving in. Only use the charging equipment provided by the factory or a charging station cable approved by the manufacturer for charging the high-voltage battery in an electric vehicle.

⚠ WARNING: Never use the charging equipment with extension cords, power strips, or items such as travel adaptors.

⚠ WARNING: Never use damaged or dirty charging equipment. Check the charging equipment for damage or debris before each use.

⚠ WARNING: Never modify or repair any electrical components, especially the high-voltage system. There are no user serviceable parts for the charging system.

⚠ WARNING: Never attempt to charge your vehicle in areas where there is a risk of explosions. The components in the charging equipment can trigger sparks, which can cause fumes to ignite. To reduce the risk of explosions, especially in enclosed areas such as garages, make sure the charging control unit is at least 19 inches (50 cm) from the floor when charging.

⚠ WARNING: Do not touch the electrical contacts on the vehicle charging port or charging equipment. Do not insert any objects in the vehicle charging port or in the charging equipment.

⚠ WARNING: Always protect the sockets and connections from moisture, water, and other liquids.

⚠ WARNING: Never transport the vehicle charging cable in the passenger compartment (such as on or in front of the seats) or unsecured.

⚠ WARNING: Do not charge the high-voltage battery during a thunderstorm.

⚠ WARNING: Before starting the vehicle, remove the vehicle charging cable, close the cover and charge port door and store the vehicle charging cable in a safe place.

⚠ WARNING: Always observe the specified sequence when charging the high-voltage battery. Do not unplug the vehicle charging cable from the electrical socket during the charging process. Finish charging before disconnecting the vehicle charging cable from the electrical socket.

⚠ WARNING: Do not disassemble, remove, or replace high voltage components, cables, or connectors.

⚠ WARNING: Read and follow all instructions provided on the labels that are attached to the vehicle. These labels are there for your safety.

⚠ WARNING: In the unlike event that a fire occurs, immediately contact your local fire emergency responders.

BATTERY CARE / INFORMATION

The Li-ion battery's ability to hold a charge, like all batteries, decreases with battery age and usage which results in decreased vehicle range when compared to the vehicle range when the vehicle was new. This is normal and expected, and does not indicate a malfunction of the vehicle or Li-ion battery.

The Li-ion battery's ability to hold a charge can be affected by how you drive the vehicle, store the vehicle, how you charge the battery and battery temperature during vehicle operation and charging.

To maximize the battery's useful life, use the following driving and charging habits where possible:

- Maintain your state of charge below 80%.
- Avoid exposing a vehicle to extreme ambient temperatures for extended periods.
- Avoid storing a vehicle in temperatures below -40°C or above $+65^{\circ}\text{C}$ for extended periods of time.
- If the State of Charge is below 15%, do not leave the vehicle unplugged for longer than 14 days.
- If the State of Charge is below 15%, it is strongly recommended to plug the vehicle to charge the battery.
- Extensive and or repeated DC fast charging can cause battery to degrade faster.
- Park/store your vehicle in cool locations out of direct sunlight and away from heat sources.

⚠ WARNING: Your vehicle contains sealed Li-ion batteries. If the Li-ion batteries are disposed of improperly, there is a risk of severe burns and electrical shock that may result in serious injury or death and there is also a risk of environmental damage.

⚠ WARNING: Do not use the Li-ion batteries for any other purpose outside of the Battista.

⚠ If the outside temperature is -40°C or less, the Li-ion battery may freeze, and it cannot be charged or provide power to run the vehicle. Move the vehicle to a warm location.

⚠ The capacity of the Li-ion battery in your vehicle to hold a charge will, like all such batteries, decrease with time and usage. As the battery ages and capacity decreases, this will result in a decrease from the vehicle's initial mileage range. This is normal, expected, and not indicative of any defect in your Li-ion battery

⚠ The battery requires no owner maintenance. Do not remove the coolant filler cap and do not add fluid. Follow the recommended maintenance schedule and have any of it performed at your authorized workshop.

⚠ Do not use the battery as a stationary power source. Doing so voids the warranty.

CHARGING INSTRUCTION

Starting to charge

- Firstly, with the vehicle unlocked, press on the rear charge port door 1 to open the port for charging. Press down on the edge closest to the rear of the vehicle to release the door from the actuator.

i NOTE there is an emergency release cable in case the door latch mechanism experiences a problem, refer to "Charge port emergency opening" section in this chapter.



i NOTE Charge port door can be unlocked by pressing button 4 on the key fob for 3 seconds which will unlock the port door.

i NOTE Depending on vehicle configuration the charge sockets will look different, but functionality remains the same.

- Upon opening the charge port door, remove plug that covers up the connections within the port - NOTE this is only necessary if performing a DC charge, if AC charging keep the cap in place.

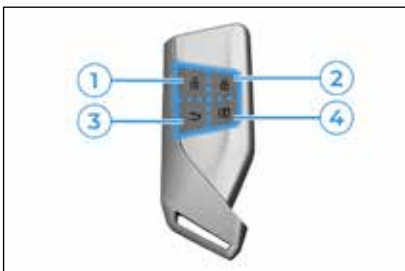

- Insert charging cable into the charging port socket firmly.



- Upon successful connection and supply of electrical current to the vehicle, the vehicle's e-Heart will pulse indicating charging has started.

⚠ Please be aware that the Battista can only be charged with CCS Type 1 (US) and CCS Type 2 (EU) – with the CCS1 Combo (US) and CCS Type 2 Combo (EU) allowing for Direct Current (DC) Fast Charging.

i NOTE Battista is only capable of fast charging on an 800V capable DC Fast Charger. It will not charge on a station not capable of 800V power supply. The navigation system will be able to provide the user with the nearest compatible charger.

i NOTE Battista is not compatible with CHAdeMO or GB/T charging stations.

Stopping Charge and Removing Cable (APPLICABLE ONLY TO THE CHARGING CABLE PROVIDED BY AUTOMOBILI PININFARINA WITH YOUR BATTISTA)

- 1 Ensure that the charge connector lock is not engaged. Vehicle key needs to be present, or vehicle needs to be unlocked to release the connector lock
- 2 Using the infotainment charging screen Press the STOP button 1 to stop the charge.



- 3 Press the release button 1 on the charge cable connector (CCS Type 1) and remove the charge cable connector from the charge port and properly store it.
- 4 Close the charge port lid.



⚠ WARNING: Do not drive the vehicle with the charging port lid open. This can damage the lid and potentially its finish.

i NOTE The above instructions are applicable only to the charging cable provided by Automobili Pininfarina with your Battista. Third-party charging equipment may have different operation instructions. Please familiarize yourself completely with the usage instructions for such third-party equipment before attempting to charge your Battista. Automobili Pininfarina is not responsible or liable for any damage caused to your Battista or third-party charging equipment not used in accordance with their respective usage guidelines.

Charge port indication (E-Heart)



E-Heart logo **F**, located under the rear glass liftgate, will indicate the status of the vehicle when being charged. It consists of an inner and outer ring of light emitting diodes (LED) that can alter their light sequence to provide the vehicle user with a visual notification.

Normal Operation

Plugging in the charge cable, the inner ring will fade on and pulse until charging session is established. While the outer ring will indicate the current level of charge, which will fully complete its 360-degree ring of LEDs when the vehicle has fully charged to 100%. When vehicle reaches its pre-set state of charge level (see “Charging Setting” section under

“Charging” chapter), the **F** logo will light up as well as the inner and outer rings until the charge cable has been removed.

Malfunction Indication

After opening the charging port lid, if there is no connection being made with a charger the inner LED ring pulsates quickly – this may indicate an issue with the charging equipment.

i NOTE The inner ring will pulsate until the malfunction has been cleared.

Identification of compatible charging connections

The signs shown below provide information about the compatibility of the car's charging components and the charging location.

The signs are located on the vehicle's charging inlet door lid (under the inner face of the door), components of the local charging infrastructure (charging station, socket) and on the charging cable.

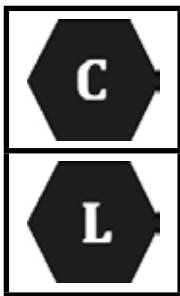

C - Label of plug type for alternating current charging (AC).

L - Identification of the connector type for charging with direct current (DC).

Charge port emergency opening

There is an emergency release cable in case the door latch mechanism experiences a problem.

Proceed as follows:

- Open the storage compartment trim.
- Remove the two screws 1 shown in the figure.
- Remove the tailgate latch cover trim.
- Pull on the Bowden release cable 2.

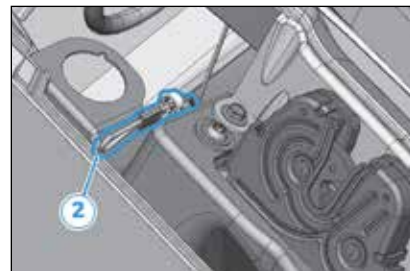
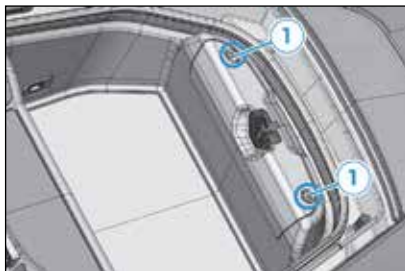

Charging setting / information on display

Battery setting / information is accessed by the user on the left display by touching the lightning bolt icon 1.



Battery Charge Control

Swiping on the touchscreen from the main charging screen, you will enter the second screen that allows you to see battery overview with charge percentage available and estimated driving distance available information.

In this screen SET LIMIT (2) and STOP/START (1) buttons are available:

- SET LIMIT by touching this button you can enter in charging limit setting screen. If the user doesn't change anything then can touch the X button to leave this screen. If the setting is changed, the user can touch the V icon to save the setting.
- STOP or START touching this button the charging session will be interrupted or started.



Charging status

When the car is charging the display shows the time remaining until fully charged at the currently selected charge level, the state of charge in the form of a percentage, the total estimated driving distance available and energy status (kW, current and voltage).

⚠ *The time to completely charge the vehicle high voltage battery varies based on the state of charge of the battery, condition and age of the battery, temperature of the battery, ambient temperature and condition of the power source*

connected to the vehicle, and whether the electric equipment (such as the air conditioner, which consumes electric power) is used.

⚠ WARNING: *Make sure there is no water or foreign materials in the charge port, charge connector, or electrical plug, and that they are not damaged or affected by rust or corrosion. If any of these conditions are noticeable, do not charge the vehicle. This may result in a short circuit or electric shock and could cause a fire which may result in serious personal injury or death.*

⚠ WARNING: *If you use any medical electric devices, such as an implantable cardiac pacemaker or an implantable cardiovascular defibrillator, check with the electric medical device manufacturer concerning the effects that charging may have on implanted devices before starting the charge operation.*

⚠ WARNING: To avoid serious personal injury or death when the vehicle is charging, be aware of the following precautions.

- Do not touch the metal contacts of the charge port, charge connector, electrical plug.
- Do not pull, twist, bend, step on, or drag the cable.

⚠ WARNING: Make sure the charge connector is removed from the charge port before starting your vehicle.

⚠ WARNING: Do not touch the plug if it's wet or with wet hands. This may cause an electric shock which may result in serious personal injury or death.

⚠ WARNING: Do not disassemble or modify the charge port. This may cause a fire or an electric shock which may result in serious personal injury or death.

⚠ WARNING: If you notice an unusual odor, smoke or abnormal noises coming from the vehicle stop charging immediately.

⚠ WARNING: Be careful not to allow your hands, hair, jewelry, or clothing to come into contact with, or get caught in, the traction motor cooling fan. The cooling fan can start at any time during charging.

⚠ WARNING: Do not allow a child to handle or use any charging equipment.

⚠ WARNING: To prevent damage to the charging Equipment do not subject the charging equipment to impact.

⚠ WARNING: Do not charge when a vehicle body cover is in use. It can prevent proper airflow to the cooling system and damage the battery as proper temperature of the battery can't be maintained during charging.

⚠ WARNING: Do not attempt to perform a recharge on the 12-volt battery at the same time that the vehicle is being charged. Doing so may damage the vehicle or charging equipment and could cause an injury.

⚠ WARNING: Before starting the vehicle, remove the vehicle charging cable, close the cover and charge port door and store the vehicle charging cable in a safe place.

⚠ WARNING: Always follow the proper sequence when charging the high-voltage battery. Do not unplug the vehicle charging cable from the electrical socket during the charging process. Complete charging before disconnecting the vehicle charging cable from the electrical socket.

HAZARD WARNING LIGHTS

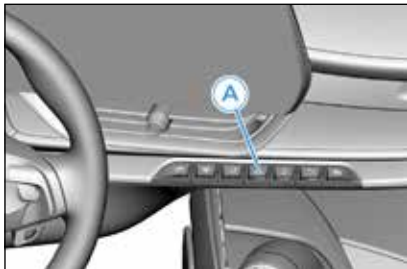

Press button A  to switch the hazard warning lights on/off. When the hazard warning lights

are on, the  and  warning lights flash.

IMPORTANT The use of hazard warning lights is governed by the highway code of the country/state you are driving in: comply with legal requirements.

The hazard lights are switched on and warning lights appear on the instrument panel in case of emergency braking. The lights switch off automatically when emergency braking ceases.

IN AN EMERGENCY

LIFTING THE VEHICLE

If raising the car is necessary, contact your Automobili Pininfarina Service Partner, who will be equipped with suitable arm or workshop lifts, in addition to the specific equipment necessary.

 **WARNING:** *Never raise the car when the charge cable is connected, even if charging is not in progress.*

 *Be careful to position the lift arms correctly at the lifting points, in order to prevent damage to the chassis and the bodywork components.*

Referencing the image shown, please lift the car in the highlighted yellow area as displayed, nothing the circled locations as lifting points.

⚠ DO NOT lift the vehicle by using the GREEN colored HV battery. If in doubt, please contact your Automobili Pininfarina Service Partner for further details.

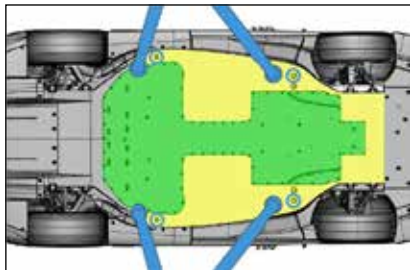

Lift only in the areas shown in the preceding illustration. For additional information, see your service provider and the service manual.

⚠ WARNING: Do not work on an incorrectly supported vehicle. Doing so can cause serious damage, bodily injury, or death.

⚠ WARNING: Lifting the vehicle could cause injury if the vehicle slips off the jacks and rolls over you or someone else.

⚠ WARNING: Getting under a vehicle when it is lifted is dangerous, it could slip and fall leading to serious injury. Never get under a vehicle when it is supported only by a jack.

12V POWER SUPPLY

In the trunk compartment of the car is located a 12V power connection point that can be used to connect the compressor (ex. to inflate the tires) or 12V battery charger included with the car.

Proceed as follows:

- Remove the cover using the anchors shown in the figure.

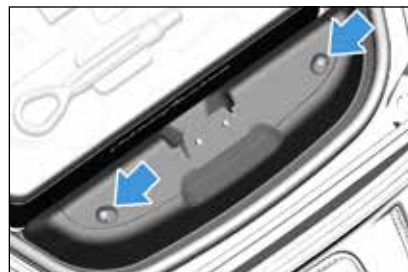

- Attach the power cord to the power port under the removed cover.



- Remove the tire inflator or the charger from the tool kit in the trunk and attach the power cable end to the car.

⚠ WARNING: Do not connect any 12V battery chargers/tenders that do not meet the specification set by Automobili Pininfarina. Use of incorrect charger on a Lithium-Ion battery can lead to damage of the battery or even possible thermal event. Your vehicle can maintain its 12V and 48V batteries and use of a battery charger should not be necessary. For any

further information contact your Automobili Pininfarina Service Partner.

TOOL KIT

The following tools are contained in a duffel bag in the luggage compartment:

- 1 Towing hook
- 2 Single nut torque tool
- 3 Battery charger
- 4 Tire Repair Kit
- 5 First AID kit
- 6 Reflective vest
- 7 Service key
- 8 Warning Triangle
- 9 Charge cable lock release tool
- 10 Reflector triangle (only for Canada and Spain market).

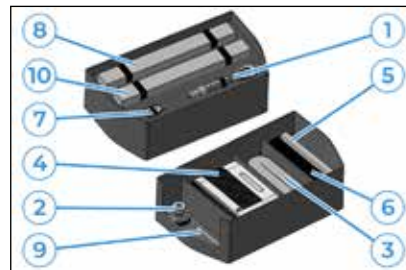

i NOTE not shown in the tool kit is a 12V system disconnect switch which will be included in the set of tools. This switch is used by your Automobili Pininfarina service partner to power down the vehicle in case of service needs.

CHARGING SOCKET UNLOCK TOOL

Part of the tool kit, which is housed in the rear trunk compartment, is a tool used for releasing the charging cable from the socket- in an event the cable was stuck and couldn't be released.

Tool consists of 2 variants that are held together:

- 1 Europe version
- 2 US version

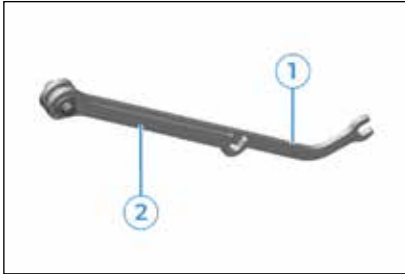

For European version

To release the cable, proceed as follows:

- Remove the protection cap 1.
- Insert the tool into the opening in the body around the charge socket and then using the tool rotate the lever 2 in clockwise rotation in order to release the charging cable.
- Remove the charging cable.

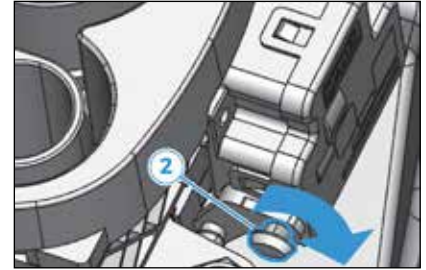

For US version

To release the cable, proceed as follows:

- Remove the protection cap 3.
- Insert the tool into the opening in the body around the charge socket and then push lever 4 towards the front of the vehicle using the tool to release the charging cable.
- Remove the charging cable.

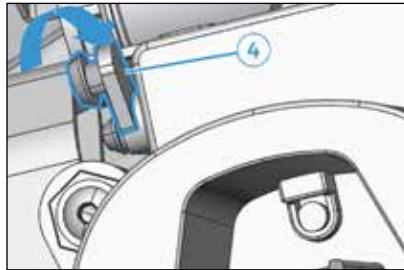

FLAT OR PUNCTURE OF TIRE

⚠ WARNING: *Automobili Pininfarina does NOT recommend repairs to its tires, the included tire inflator kit is only to be used in an emergency case to continue the drive but not for prolonged period of time. Please do not exceed 80km/h or 50MPH with the sealant installed in the tire. Your Automobili Pininfarina Service Partner will have the capability to replace your damaged tire for you.*

ONLY applies to countries part of Gulf Cooperation Council (Kuwait, Bahrain, Oman, Qatar, Saudi Arabia, United Arab Emirates (UAE), Yemen): The trunk-mounted tire inflator kit replaces the spare tire, which is not available on the Battista. Automobili Pininfarina Service Provider will be happy to assist you in case you experience a puncture or a flat tire on your vehicle.

i **NOTE** Automobili Pininfarina does not warranty the tires, only the manufacturer of the tire can provide a warranty on conditions it deems warrantable.

! WARNING: Do not attempt to drive with a punctured tire that has not been replaced, even if the puncture has not caused the tire to deflate. A punctured tire can deflate without warning at any time.

Tire repair kit

Tire Repair Kit is contained in a duffel bag in the luggage compartment.

Proceed as follows to use the Tire Repair Kit:

- Stop the vehicle in a position that is not dangerous for oncoming traffic where you can repair the tire safely, as far as possible from the side of the road.
- Turn on the hazard warning lights.
- Engage in P (Park) mode.

- Put on the reflective safety jacket included in the tool kit (for your own safety and to comply with the regulations in force in the country where you are) before getting out of the car.
- When the situation requires it (for your own safety and to comply with the regulations in force in the country where you are), take the warning triangle from the luggage compartment and position it at a suitable distance from the car.
- The Tire Repair Kit is placed in the trunk compartment in the supplied suitcase for emergency situations.



The Tire Repair Kit consists of:

- 1 ON/OFF button
- 2 Pressure release button
- 3 Pressure gauge
- 4 Sealant hose
- 5 Air hose
- 6 Canister eject button
- 7 Power cable
- 8 Compressor
- 9 Integrated sealant canister
- 10 Function selector switch.

Repair procedure

Proceed as follows:

- Connect the sealant hose to the flat tire valve stem.
- Attach the electrical connector to the 12V supply located in the storage compartment (refer to section “12V power supply” in this chapter).
- Turn the function selector switch to left and turn on the kit.
- Inflate tire to specified pressure found in “Technical data” chapter or on the door sticker.
- Turn off and remove the tire inflator once specified pressure has been attained.
- Resume driving and monitor the tire pressure via the tire pressure screen.

Checking and restoring tire pressure

The compressor can also be used to check and, if necessary, restore the tire pressure.

Proceed as follows:

- Connect the air hose to the tire that is low on pressure.
- Attach the electrical connector to the 12V supply.
- Turn the selector switch to right, then turn on the kit until the correct pressure is reached.

ONLY applies to countries part of the Global Corporate Council (Kuwait, Bahrain, Oman, Qatar, Saudi Arabia, United Arab Emirates (UAE), Yemen): your vehicle does not come equipped with a spare tire nor does it come with a type of a tire that allows you to drive even if there is no pressure (Run Flat Tire). In case of a tire-related problem- like a puncture, your Automobili Pininfarina Service Partner will be more than happy to help you.

For the most up-to-date list of service partners, please visit www.automobili-pininfarina.com

⚠ WARNING: *Drive carefully, particularly on bends. Do not exceed 80 km/h – 50 mph. Avoid sudden acceleration or braking.*

⚠ WARNING: *Punctures on the sides of the tire may not be repaired. Do not use the Tire Repair kit if the tire was damaged as a result of being used when underinflated.*

⚠ WARNING: *Repairs are not possible in the case of damage to the wheel rim (bad groove distortion causing air loss). Do not remove foreign bodies (screws or nails) from the tire.*

⚠ WARNING: *Never operate the compressor for longer than 20 consecutive minutes. Risk of overheating. The Tire Repair Kit is not suitable for definitive repairs, so the repaired tires may only be used temporarily.*

⚠ WARNING: *As required by current regulations, the information on chemical substances for the protection of human health and the environment and on the safe use of the sealing fluid are on the canister label. Compliance with the indications on the label is an essential condition to ensure the safety and the effectiveness of the product. Remember to carefully read the label before use; the user of the product is responsible for any damage caused by improper use. The sealing fluid has an expiry date. Replace the bottle if the sealant has expired.*

MAINTENANCE

SCHEDULED SERVICING

Automobili Pininfarina recommends the following maintenance items and intervals to ensure continued reliability and efficiency of your car. Correct servicing is crucial for guaranteeing a long life for the vehicle under the best conditions.

IMPORTANT Scheduled Servicing operations are required by the Manufacturer. Failure to have them carried out may invalidate the warranty.

Component	Action taken	1 Year or 10k KM	2 Year or 20k KM	3 Year or 30k KM	4 Year or 40k KM	5 Year or 50k KM	6 Year or 60k KM
Check for any open campaigns	Inspect	x	x	x	x	x	x
Replace wiper blades	Replace	x	x	x	x	x	x
Replace key fob batteries	Replace	x	x	x	x	x	x
Top off windshield washer fluid	Replace	x	x	x	x	x	x
Check and top off coolant	Inspect	x	x	x	x	x	x

Component	Action taken	1 Year or 10k KM	2 Year or 20k KM	3 Year or 30k KM	4 Year or 40k KM	5 Year or 50k KM	6 Year or 60k KM
Lubricate door/hatch closure mechanisms	Lubricate	x	x	x	x	x	x
Verify horn operation	Function check	x	x	x	x	x	x
Check all exterior light functions	Function check	x	x	x	x	x	x
Verify charge cable operation and clean any debris from charge cable and port	Function check & Clean	x	x	x	x	x	x
Vehicle health check (DTC diagnosis)	Inspect	x	x	x	x	x	x
Cabin filter	Replace	x	x	x	x	x	x
ePT/HV battery coolant replacement	Replace					x	
Perform active thermal test	Function check	x	x	x	x	x	x
Inspect wheels and tires (bends, cuts, uneven wear)	Visual inspection	x	x	x	x	x	x

Component	Action taken	1 Year or 10k KM	2 Year or 20k KM	3 Year or 30k KM	4 Year or 40k KM	5 Year or 50k KM	6 Year or 60k KM
Clean and lubricate wheel nuts and O-rings on lock rings and nuts	Lubricate	x	x	x	x	x	x
Check and record tire tread depths (outside, center, inside) for all 4 tires	Check	x	x	x	x	x	x
Inspect and adjust tire pressures	Check & adjust	x	x	x	x	x	x
Road-force wheel balance all 4 tires	Check	x	x	x	x	x	x
4-wheel alignment	Performed	x	x	x	x	x	x
Brake inspection - record wear of pads and brake rotors	Visual inspection	x	x	x	x	x	x
Check all brake and coolant hoses	Visual inspection	x	x	x	x	x	x
Check underbody and battery enclosure for any damage or leaks	Inspect	x	x	x	x	x	x
Inspect all suspension components for any wear/play or damage	Inspect	x	x	x	x	x	x

Component	Action taken	1 Year or 10k KM	2 Year or 20k KM	3 Year or 30k KM	4 Year or 40k KM	5 Year or 50k KM	6 Year or 60k KM
Inspect all steering components for any wear/play or damage	Inspect	x	x	x	x	x	x
Re-torque all suspension components	Inspect	x	x	x	x	x	x
Brake fluid	Replace		x		x		x
Hydraulic fluid check (spoiler and suspension lift)	check	x	x	x	x	x	x
Desiccant replacement of HV Battery	Replace					x or if the vehicle indicates that is needed	
Hydraulic fluid and filter - air and suspension lift	Replace					x	
Verify vehicle has latest software - update	Inspect	x	x	x	x	x	x

BASIC SERVICING PROCEDURES

⚠ WARNING: Always disconnect the charge cable before working underneath vehicle, even if charging is not in progress.

⚠ WARNING: Keep your hands and clothing away from cooling fans. Some fans operate even when the vehicle is powered off.

⚠ WARNING: Some fluids (coolant, brake fluid, windshield washer additive...) used in the vehicle are poisonous and should not be inhaled, swallowed, or brought into contact with open wounds. For your safety always follow instructions printed on fluid containers.

⚠ WARNING: Contact your authorized Automobili Pininfarina Service Provider with any questions regarding maintenance or service you may have.

⚠ *Incorrect servicing of the vehicle or failure to carry out operations or repairs (when necessary) may lead to more expensive repairs, damage to other components or have a negative impact on the vehicle performance.*

Cleaning/replacing wiper blades

Periodically clean the windscreen and rear window and rubber profile of the windscreen wiper blades, using a sponge or a soft cloth and a non-abrasive detergent. This eliminates the salt or impurities accumulated while driving.

Prolonged operation of the windscreen window wipers with dry glass may cause the deterioration of the blades, in addition to abrasion of the surface of the glass. To eliminate the impurities on the dry glass, always operate the windscreen washers.

In the event of very low outdoor temperatures, below zero degrees, ensure that the movement of the rubber part in contact with the glass is not obstructed. Use a suitable deicing product to release it if required.

Fully defrost the windscreen before using the windscreen wipers.

⚠ WARNING: *Driving with worn windscreen wiper blades is a serious risk because visibility is reduced in bad weather conditions.*

For optimum performance replace the wiper blades at least once a year or if you notice wiper's performance has degraded.

Checking the battery coolant

If the quantity of fluid in the cooling system drops below the recommended level, the instrument panel displays a warning message. Stop driving as soon as safety permits and contact Automobili Pininfarina Service Provider.

⚠ WARNING: Battery coolant can be hazardous and can irritate eyes and skin. Under no circumstances should you remove the filler cap and/or add coolant. If the instrument panel warns you that the fluid level is low contact Automobili Pininfarina Service Provider immediately.

Checking brake fluid

Checking brake fluid is not possible without having to remove the bonnet. Please contact your Automobili Pininfarina Service Partner.

⚠ WARNING: Stop driving as safely as possible and contact Automobili Pininfarina nearest immediately if you notice increased movement of the brake pedal, dedicated red brake indicator on the instrument



screen **BRAKE** or a significant loss of brake fluid. The red brake indicator on the instrument screen alerts you if the quantity of fluid in the brake reservoir drops below the recommended level. Driving under these conditions can result in extended stopping distances or complete brake failure.

⚠ WARNING: DO NOT PERSONALLY TOP UP YOUR BRAKE FLUID, LOW FLUID MAY INDICATE A PROBLEM.

⚠ WARNING: Only use fluid from new, airtight containers.

⚠ WARNING: Brake fluid is highly toxic. Keep it out of the reach of children. In the event of accidental consumption, seek medical attention immediately.

⚠ Brake fluid damages painted surfaces. Immediately soak up any spills with an absorbent and wash the area with a mixture of car shampoo and water.

Topping up windshield washer fluid

To top up the washer fluid proceed as follows:

- Turn the steering wheel all the way to the left.
- Remove the cap 1 from the washer tank.
- Clean around the filler cap.

⚠ WARNING: *Windshield washer fluid can irritate the eyes and skin. Follow the instructions provided by the washer fluid manufacturer.*

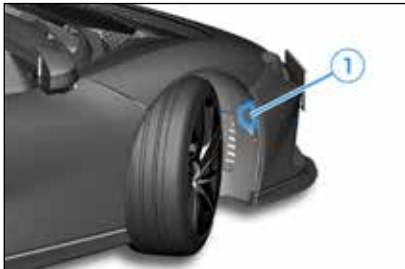

RIMS AND TIRES

Rims

	Front	Rear
Standard	10" J x 20" ET 46,5	11,5" J x 20" ET 58
Optional	9,5" J x 20" ET 40,5	12" J x 21" ET 67,5

Explanation of wheel rim codes

Example: 10" J x 20" ET 46,5

10" = Rim width in inches

J = Shape of rim edge (side projection where tire bead rests)

20" = Rim diameter in inches

ET 46,5 = Offset (distance, in mm, between the centerline of the rim and inner rim surface)

Tires

Tire Marking



Explanation of codes and wording on tire side walls

1 Tire size and characteristics

Example: 265/35 ZR 20 (99Y)

265 = Nominal width (distance in mm from side to side)

35 = Height/width ratio as a percentage

ZR = Radial tire that can withstand speeds above 240 km/h.

Combined with the specific load and speed code (in brackets), this indicates a tire that can withstand speeds above 300 km/h.

20 = Rim diameter in inches

99 = Load index: numerical code associated with the maximum load permissible on the tire at a given pressure, at the speed corresponding to the relative index. The maximum load permissible is indicated in kg and pounds in the wording (3).
Y = Speed index

This indicates the maximum speed at which the tire can withstand the load indicated in the load index. Speed indexes (ECE-UN 30) are shown in the table below:

Speed Index	Maximum Speed (km/h)
M	130
N	140
P	150
Q	160
R	170
S	180
T	190
U	200
H	210
V	240
W	270
Y	300
ZR (...Y)	>300

The speed index Y, shown in brackets and associated with the abbreviation ZR, indicates a tire that can withstand speeds above 300 km/h.

- 2 EXTRA LOAD: tire with a high load capacity
- 3 Maximum load permissible, indicated in kg and pounds, and maximum inflation pressure permissible, indicated in kPa/bar and psi.
- 4 TUBELESS: the tire has no air chamber
- 5 RADIAL: radial tire
- 6 Details of materials used to construct the tread and tire side wall.
- 7 DOT XX YY ZZ NNNN
DOT (Department of Transportation) specifications: marking relative to US regulations, with information on the manufacturer, production site, tire type and size. The last four digits, in a box, indicate the date of manufacture.

8 Uniform Tire Quality Grading: standard, defined by the US Department of Transportation, that classifies tire performance in terms of treadwear, traction and temperature resistance.

Treadwear

The treadwear grade is a comparative rating based on the wear rate of the tire when tested under controlled conditions on a specified government test course. For example, a tire graded 150 would wear one and one-half (1½) times as well on the government course as a tire graded 100. The relative performance of tires depends upon the actual conditions of their use, however, and may depart significantly from the norm due to variations in driving habits, service practices and differences in road characteristics and climate.

Traction

The traction grades, from highest to lowest, are AA, A, B, and C. Those grades represent the tire's ability to stop on wet pavement as measured under controlled conditions on specified government test surfaces of asphalt and concrete. A tire marked C may have poor traction performance.

 **WARNING:** *The traction grade assigned to this tire is based on straight-ahead braking traction tests, and does not include acceleration, cornering, hydroplaning, or peak traction characteristics.*

Temperature

The temperature grades are A (the highest), B, and C, representing the tire's resistance to the generation of heat and its ability to dissipate heat when tested under controlled conditions on a specified indoor laboratory test wheel. Sustained high temperature can cause the material of the tire to degenerate and reduce tire life, and excessive temperature can lead to sudden tire failure. The grade C corresponds to a level of performance which all passenger car tires must meet under the Federal Motor Safety Standard No. 109. Grades B and A represent higher levels of performance on the laboratory test wheel than the minimum required by law.

⚠ WARNING: *The temperature grade for this tire is established for a tire that is properly inflated and not overloaded. Excessive speed, underinflation, or excessive loading, either separately or in combination, can cause heat buildup and possible tire failure.*

Tire Usage and Maintenance

⚠ *Have worn tires replaced in axle pairs and ensure the tires are fitted as specified. With worn tires, the driving stability of the vehicle will be adversely affected, especially when driving at high speeds.*

- With new tires, avoid high speed cornering and excess speed.
- Tires degrade over time because of ultraviolet light, extreme temperatures, high loads, and environmental conditions. It is recommended that tires are replaced every 4 years, or sooner if required.
- All wheels must have a valve cap fitted to protect the valve against dirt and moisture.
- Store tires in a cool, dry place, preferably in the dark. Protect the tires from oil, grease, and petrol. Storing temperature must be above 0°C.

⚠ *Driving with tire pressure that is too high or too low can:*

- *Create a risk of tire failure with resultant accidents, causing injury or death.*
- *Shorten the life of the tires.*
- *Cause increased tire damage.*
- *Have a negative effect on handling characteristics (e.g., by causing aquaplaning).*

⚠ *Using tires other than those which have been recommended by Automobili Pininfarina (refer to "Automobili Pininfarina Approved Tires" in "Technical data" Chapter), may contact the body work and adversely affect the handling. This may cause loss of vehicle control, resulting in serious personal injury or death. Noise levels and energy consumption may also be adversely affected. In addition, when driving with a load or when using snow traction devices, they could cause contact between the bodywork and axle components.*

This could result in damage to the tires or the vehicle

⚠ *The tires must be mounted according to the labelling on the tire wall. The word OUTSIDE must be on the outer edge of the tire when it is fitted to the wheel or the stability of the vehicle will be adversely affected, especially at high speeds:*

IMPORTANT If there are any discrepancies between the Owner Handbook and the Registration Document, take the information from the latter. For safe driving, the car must be fitted with tires of the same make and type on all wheels. Automobili Pininfarina cannot determine if unapproved tires are suitable for use and therefore cannot guarantee vehicle safety in those conditions.

⚠ *The road holding qualities of the car also depend on the correct inflation pressure of the tires.*

Michelin® CUP2/2R Tires.

The driver's skill level must be commensurate with the vehicle performance levels in the upper range limits due to increased safety risks.

i **NOTE** *Due to ultra-high-performance design and the manufacturing process of these tires, they must always be replaced in car sets (front and rear) regardless of wear or mileage. Failure to do so may have a negative effect on the handling characteristics of the vehicle.*

⚠ **WARNING:** *Risk of accident from worn tires. Michelin® CUP2/2R tires have a shallower tread depth, and thus can reach their wear limit sooner. It is important to check tire wear frequently to avoid risk of serious personal injury or death from worn tires.*

⚠ **WARNING:** *As a special tire for extremely dry conditions whose technologies were developed in the motorsport sector, the Michelin® CUP2/2R requires a warm-up phase just like in motor racing in order to ensure optimum performance.*

⚠ **WARNING:** *Risk of accident through loss of road surface contact, control over the vehicle and braking ability, leading to serious personal injury or death. The reduced tire tread depth means that there is an increased risk of aquaplaning on wet roads. When driving on wet or mud-covered roads reduces speed significantly*

⚠ **WARNING:** *Michelin® CUP2/2R Tires stored below -10°C degenerate with the result that they lose performance and can cause rubber fracture. Below -10°C (14°F) Michelin® CUP2/2R tires should be neither used, stored, moved, or shipped.*

⚠ WARNING: *Michelin® CUP2/2R Tires stored as with all semi-slicks, there is a tendency for aquaplaning on wet racetracks or road surfaces, especially towards the end of their useful life. In wet conditions, you should drive particularly carefully, with reduced weight and with safety systems and driving assistance systems activated.*

CAR INACTIVITY (LONG TERM STORAGE)

Electric cars are designed to be used frequently.

A battery left discharged for a long time could be irreparably damaged.

Therefore, it should be kept at a constant charge level between 50 and 80% of the capacity.

Parked vehicle should be monitored and recharged - your Battista mobile application will allow you to monitor your vehicle.

Furthermore, vehicle allows the user to adjust their maximum charge level. If possible, keep the vehicle always plugged in and do not charge over 80% unless necessary - for example road trip or maximum performance.

Once you reach that level, the session should still be stopped.

Furthermore, the tires stationary in the same position may be flattened. For an electric car, which is heavier, this is even more true. It would therefore be a good rule to move the car 30-40 centimeters every two or three weeks.

i *NOTE while Battista is always connected to the Internet, there will be moments where its connection may be weak or not present – such as in parking structures or in areas where cellular signal is weak. Automobili Pininfarina recommends that, if possible, please connect your Battista to a wireless network – WiFi to ensure it can register the vehicle on-line.*

Moreover, if the vehicle is left inactive for longer than a month, the following precautions should be observed:

- Park the car in covered, dry and if possible well-ventilated premises and slightly open the windows.
- Clean and protect the painted parts using protective wax.
- Clean and protect the shiny metal parts using special compounds available commercially.
- Sprinkle talcum powder on the windscreen wiper rubber blades and lift them off the glass.
- Use dedicated tire pillow or inflate tires to +0.5 bar above the standard prescribed pressure and check it periodically:
- Any time the car is left inactive for two weeks or more, operate the air conditioning system for at least 5 minutes, setting external air and with fan set to maximum speed.

This operation will ensure appropriate lubrication for the system, thus minimizing the possibility of damage to the compressor when the system is operated again.

⚠ WARNING: *It is advised if the vehicle is going to be left plugged in and charging; to not use any kind of car cover not approved by Automobili Pininfarina as the vehicle will not be able to correctly control its temperature.*

PRESERVING THE BODYWORK

Touch up abrasion and scratches immediately to prevent paint chipping.

Maintenance of paintwork consists of washing the car: the frequency depends on the conditions and environment where the car is used. For example, it is advisable to wash the car more often in areas with high levels of atmospheric pollution or salted roads.

To correctly wash the vehicle, follow these instructions:

- If high pressure jets or cleaners are used to wash the vehicle, keep a distance of at least 40 cm from the bodywork to avoid damage or alteration. Build-up of water could cause damage to the car in the long term.
- Wash the bodywork using a low-pressure jet of water if possible.
- Wipe a sponge with a slightly soapy solution over the bodywork, frequently rinsing the sponge.
- Rinse well with water and dry with a jet of air or a chamois leather.

i **NOTE** *Let the vehicle dry fully as opening the doors may allow some water to drip into the cabin due to the nature of the doors on the vehicle.*

Windows

Use specific detergents and cleaning cloths to prevent scratching or altering the transparency.

Front headlights

Use a soft cloth soaked in water and detergent for washing cars.

IMPORTANT Never use aromatic substances (e.g., petrol) or ketones (e.g., acetone) for cleaning the plastic lenses of the headlights.

⚠ *Avoid washing with rollers and/or brushes in washing stations. Wash the car only by hand using neutral pH detergents; dry it with a wet chamois leather. Abrasive products and/or polishes should not be used for cleaning the car. Bird droppings must be washed off immediately and thoroughly as the acid they contain is particularly aggressive.*

Avoid (if possible) parking the vehicle under trees; remove vegetable resins immediately as, when dried, it may only be possible to remove them with abrasive products and/or polishes, which is highly inadvisable as they could alter the typical opaqueness of the paint. Do not use pure windscreen washer fluid for cleaning the front windscreen; dilute it min. 50% with distilled water. Only use pure screen washer fluid when strictly necessary due to outside temperature conditions

 Detergents pollute the environment. Only wash your vehicle in areas equipped to collect and treat wastewater from this type of activity.

Interior

Periodically check the status of interior cleaning, below carpets, also to avoid the possible damage to parts in carbon.

Parts in Alcantara

Remove the dust with a soft brush or using a vacuum cleaner and using specific cleaner products.

Leather seats

Remove the dry dirt with a buckskin or just a moist cloth, without exercising too much pressure.

Plastic parts, in carbon and coated

Clean the plastics internal and exposed carbon with a possibly microfiber cloth moistened in a solution of water or non-abrasive neutral detergent.

Coated parts in real leather

To clean these components, use only water and neutral soap. Never use alcohol or base products alcoholic.

 **WARNING:** Never use flammable products, such as petrol ether or rectified petrol to clean the inside of the car.

Never use alcohol, petroleum, and derivatives to clean the dashboard and instrument panel lens.

 Never use alcohol, petroleum, and derivatives to clean the dashboard and instrument panel lens.

VEHICLE TRANSPORTATION

If transporting the Battista by means of air cargo, it may be necessary to completely shut down the vehicle- differently from normal vehicle power off. This is because the vehicle's systems may, like your cellular phone, cause interference with the plane's avionics. Please contact Automobili Pininfarina or your service partner for assistance.

TECHNICAL DATA

IDENTIFICATION DATA

Vehicle identification number (vin)

The Vehicle Identification Number (VIN) for US / Canada / GSO is stamped on a plate 1 on the front left corner of the dashboard trim, which can be seen from outside the vehicle, through the windscreen.



The Vehicle Identification Number (VIN) for EU regulation is stamped on plate 2 on the right side of passenger compartment.

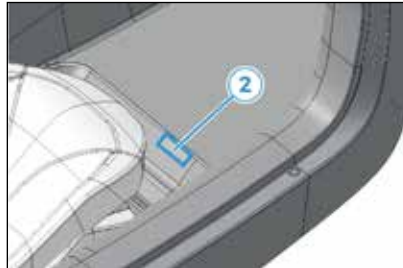

Manufacturer label

Label 1 is located in the point shown in the figure and reports the data about:

- VIN number
- Masses
- MY (US/CAN/GSO)



EU manufacturer label



US manufacturer label



Canada manufacturer label

Soft-top label

- The label 1 is located on the driver's side roof inner panel.

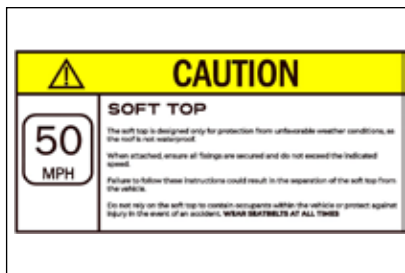
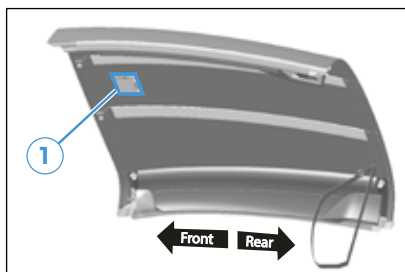

Tires label

- The label 1 is located on the left side front door pillar.



TIRE AND LOADING INFORMATION				
SEATING CAPACITY		TOTAL 2	FRONT 2	REAR 0
The combined weight of occupants and cargo should never exceed 200 Kg or 441 lbs.*				
TIRE	SIZE	COLD TIRE PRESSURE		SEE OWNERS MANUAL FOR ADDITIONAL INFORMATION
FRONT	275/35 R20	280KPA, 41PSI		
REAR	315/35 R20	280KPA, 41PSI		
SPARE	NONE	NONE		

US market tire label

TIRE AND LOADING INFORMATION				
SEATING CAPACITY		TOTAL 2	FRONT 2	REAR 0
The combined weight of occupants and cargo should never exceed 200 kg or 441 lbs.* Le poids total des occupants et du chargement ne doit jamais dépasser 200 kg ou 441 lbs.*				
TIRE PNEU	SIZE DIMENSIONS	COLD TIRE PRESSURE PRESSION DES PNEUS A FROID		SEE OWNER'S MANUAL FOR ADDITIONAL INFORMATION VOIR LE MANUEL DE L'USAGER POUR PLUS DE RENSEIGNEMENTS
FRONT AVANT	265/35 R20	280KPA, 41PSI		
REAR ARRIERE	325/30 R21	280KPA, 41PSI		
SPARE DE SECOURS	NONE/AUCUNE	NONE/AUCUN		

Canada market tire label

TIRE AND LOADING INFORMATION				
SEATING CAPACITY		TOTAL 2	FRONT 2	REAR 0
The combined weight of occupants and cargo should never exceed 200 Kg or 441 lbs.*				
TIRE	SIZE	COLD TIRE PRESSURE		SEE OWNERS MANUAL FOR ADDITIONAL INFORMATION
FRONT	265/35 R20	280KPA, 41PSI		
REAR	325/30 R21	280KPA, 41PSI		
SPARE	NONE	NONE		

US market optional tire label

TIRE AND LOADING INFORMATION				
SEATING CAPACITY		TOTAL 2	FRONT 2	REAR 0
The combined weight of occupants and cargo should never exceed 200 kg or 441 lbs.* Le poids total des occupants et du chargement ne doit jamais dépasser 200 kg ou 441 lbs.*				
TIRE PNEU	SIZE DIMENSIONS	COLD TIRE PRESSURE PRESSION DES PNEUS A FROID		SEE OWNER'S MANUAL FOR ADDITIONAL INFORMATION VOIR LE MANUEL DE L'USAGER POUR PLUS DE RENSEIGNEMENTS
FRONT AVANT	275/35 R20	280KPA, 41PSI		
REAR ARRIERE	315/35 R20	280KPA, 41PSI		
SPARE DE SECOURS	NONE/AUCUNE	NONE/AUCUN		

Canada market optional tire label

Vehicle emission control information label (VECI)

The label 1 is located in the point shown in the figure.



 AUTOMOBILI PININFARINA GmbH VEHICLE EMISSION CONTROL INFORMATION	
Conforms to regulations U.S. EPA/Canada: TB30 LDV California: ZEV PC	2022 MY BEV Fuel: Electric Fuel: Electric
Battery Electric Vehicle Group: NAPFV0.00PFO	

GEARBOXES

Type	Single speed gearboxes with helical cut gear sets
------	---

BRAKES

Type	Electro-Hydraulic brake system
Calipers	6 piston Brembo
Rotor diameters	390mm
Front rotor thickness	34mm
Rear rotor thickness	34mm
Front brake pad thickness	10.5mm
Rear brake pad thickness	10.5mm
Parking brake	Electronic Parking Brake on rear wheels

SUSPENSION

Front	KW electronically adjustable coil over
Rear	KW electronically adjustable coil over

BATTERY

Battery – 12 V

Nominal capacity	40Ah
Nominal voltage	13.2V

Battery – 48 V

Nominal capacity	8Ah
Nominal voltage	46.2V

Battery High Voltage

Type	Lithium-Ion liquid cooled battery
Nominal voltage	626V
Capacity	120 kWh

STEERING

Type	Electronic Power Assisted Steering
------	------------------------------------

AUTOMOBILI PININFARINA APPROVED TIRES

	Axle	Brand and name	Size	Inflation pressure (cold)	Inflation pressure (high speed > 250 kph)
Michelin® Pilot Sport 4S	Front	Michelin® Pilot Sport 4S K1	275/35 ZR20 (102Y) XL	2,8 bar /41 psi	3,4 bar/49 psi
	Rear	Michelin® Pilot Sport 4S K1	315/35 ZR20 (110Y) XL	2,8 bar /41 psi	3 bar/43,5 psi
Michelin® Pilot Sport CUP2/2R	Front	Michelin® Pilot Sport CUP2 N2/ CUP 2R N0	265/35 ZR20 (99Y) XL	2,8 bar /41 psi	3,4 bar/49 psi
	Rear	Michelin® Pilot Sport CUP2 N2/ CUP 2R N0	325/30 ZR21 (108Y) XL	2,8 bar /41 psi	3 bar/43,5 psi -CUP2 3,4 bar/49 psi-CUP2R

 Consult your Automobili Pininfarina dealer for advice and information regarding the maximum speed specified for the winter tires fitted.

DRIVING ON SNOW

Your Automobili Pininfarina Service Partner can advise you on the winter tire or chain that is suitable for your vehicle.

Automobili Pininfarina recommend that you only use snow chain which have been approved for Battista. If you are intending to fit snow chain, bear the following points in mind:

- Only ever fit snow chains to both rear wheels
- Comply with the manufacturer's installation instructions
- Do not exceed the maximum permissible speed as indicated on the snow chain packaging.
- Remove the snow chain as soon as possible if you are no longer driving on snow covered roads.

Please refer to the following table to check rear tire size which can be equipped with snow chain:

Axle	Brand and name	Size	Chain applicability
Rear	Michelin® Pilot Sport 4S K1	315/35 ZR20 (110Y) XL	YES
Rear	Michelin® Pilot Sport CUP2/2R N0	325/30 ZR21 (108Y) XL	NO
Rear	Winter Tires	305/35ZR20 (107W) XL	YES

 *Pura is the recommended Drive Mode when driving with snow chains or low grip conditions such as snow.*

 **Note:** 1 Bar of pressure = 100 Kilopascals(KPA).



DIMENSIONS

Exterior

Overall Length	4912 mm
Overall width with mirrors extended	2240 mm
Overall height	1214 mm
Overhang	
Front	1174 mm
Rear	993 mm
Wheelbase	2745 mm
Track with Prezioso wheels	
Front	1700 mm
Rear	1708 mm

WEIGHTS

Curb weight	2302 kg
-------------	---------

FLUIDS AND LUBRICANTS

Washer fluid capacity	1L
-----------------------	----

CONFORMITY DECLARATION FOR FREQUENCY

TPMS	<p>General Safety: IEC 60950-1:2005 EN 60950-1:2006 + A11:2009 + A1:2010 + A12:2011</p> <p>EMC: EN 301 489-1 V1.8.1:2008 EN 301 489-3 V1.4.1:2002</p> <p>Radio Frequency: EN 300 330-1 V1.7.1:2010/02 EN 300 330-2 V1.3.1:2006/04</p>
	FCC
	Identifier: T4510204
	Name of Grantee: LDL Technology
	Rule Parts: 15.231
	Frequency Range (MHz): 433.92 – 433.92
TPMS	<p>IC Number: 11-114073 IC: 6450A-10204 Frequency Range: 433.92 MHz</p>

TPMS Wheel	<p>General Safety: IEC 60950-1:2005 EN 60950-1:2006 + A11:2009 + A1:2010 + A12:2011</p> <p>EMC: EN 301 489-1 V1.9.2:2011 EN 301 489-3 V1.6.1:2013 EN 61000-4-2:2009 EN 61000-4-3:2006 + A1 2008 + A2 2010</p> <p>Radio Frequency: EN 300 330-1 V2.4.1:2012/05 EN 300 330-2 V2.4.1:2012/05 EN 300 330-1 V1.7.1:2010/02 EN 300 330-2 V1.5.1:2010/02</p>
TPMS Wheel	<p>FCC Identifier: YMY030189 Name of grantee: Alligator Ventilfabrik GmbH Rule parts: 15.231(e) Frequency Range (MHz): 433.92 – 433.92</p>
TPMS Wheel	<p>IC Certification number: 9157A-030189 (New family) Frequency range: 433.92 MHz</p>
TPMS Wheel	<p>ICC Certification number: R-C-Avg-030 Frequency range: 433.92 MHz</p>

<p>SKS (Smart Key System)</p>	<p>CE General Safety: EN 62311:2008 EN 62368-1:2014 + A11:2017 EMC: EN 303 446-1 V1.2.1 Radio Frequency: EN 300 220-2 V3.2.1 EN 300 330 V2.1.1 FCC Identifier: 2A2HN-RIM1404 Name of Grantee: Rimac automobile d.o.o. Rule Parts: 47 CFR FCC Part2.1093 47 CFR FCC Part2.1091 47 CFR Part 15, Subpart C (§15.203,§15.207 (a), §15.205; §15.209; §15.215) 47 CFR Part 15, Subpart C (§15.203,§15.207 (a), §15.205; §15.209; §15.215; §15.249) Amendment (Clause 7.2) Frequency Range: 125 KHz Frequency Range: 914.2 – 915.4 MHz</p>
---------------------------------------	---

<p>ICU</p>	<p>Rimac Infotainment Control Unit (RIM_ICU)</p> <p>Model: ICU_301_RIM_03_E (EMEA)</p> <p>Operating Voltage: 14,4 V (8V - 16V allowable)</p> <p>Europe</p>  <p>Declaration of Conformity regarding: RE Directive 2014/53/EU EMC Directive 2014/30/EU RoHS Directive 2011/65/EU</p> <p>Manufacturer: Rimac Automobili d.o.o. Ljubljanska 7, Sveta Nedelja, Croatia</p> <p>EU Representative: Rimac Automobili d.o.o. Ljubljanska 7, Sveta Nedelja, Croatia</p> <p>Hereby, Rimac Automobili declares that ICU_301_RIM_03_E is in compliance with EMC Directive 2014/30/EU and embeds following radio modules compliant with RE Directive 2014/53/EU</p> <ul style="list-style-type: none"> • TOBY-L210-03A from U-BLOX (GSM, UMTS, LTE) • JODY-W164-07A from U-BLOX (Bluetooth and Wi-Fi) • NEO-M8L-03A from U-BLOX (GNSS) <p>Frequency band(s) in which the radio equipment operates:</p> <ul style="list-style-type: none"> • 832 MHz - 915 MHz, 1710 - 2170 MHz, 2.5 GHz - 2.57GHz <p>GSM, UMTS, LTE)</p> <ul style="list-style-type: none"> • 2.4 GHz - 2.5GHz (Bluetooth and Wi-Fi) • 4.9 GHz - 5.845 GHz (Wi-Fi) <p>Maximum radio-frequencies power transmitted in the frequency band(s) in which the radio equipment operates</p> <ul style="list-style-type: none"> • 0,899mW/cm² (for 832 MHz - 915 MHz) • 0,974mW/cm² (for 1710 - 2170 MHz) • 18dBm (for 2.4 GHz - 2.5GHz) • 15dBm (for 4.9 GHz - 5.845 GHz)
------------	---

NEW VEHICLE LIMITED WARRANTY

GENERAL WARRANTY PROVISIONS

This chapter defines the terms, conditions, and limitations under which Automobili Pininfarina will provide repairs to the vehicle during the applicable warranty period.

Only Automobili Pininfarina Service Partners who are appointed and receive full technical support from Automobili Pininfarina can perform warranty repairs or replacements. Automobili Pininfarina Service Partners must carry out these remedial measures straight away according to technical requirements.

Warranty responsible

For vehicles registered in the United States and Canada:

Automobili Pininfarina Americas Inc.
275 Rex Blvd Auburn Hills, MI
48326-2954
1-833-975-0915

For vehicles registered in Europe:

Automobili Pininfarina GmbH
Dingolfinger Str. 9
81673 Munich, Germany.
+800-55445544

Limitations and Disclaimers

THIS NEW VEHICLE LIMITED WARRANTY IS THE ONLY EXPRESS WARRANTY MADE IN CONNECTION WITH YOUR AUTOMOBILI PININFARINA VEHICLE. Implied and express warranties and conditions arising under applicable state or provincial laws or federal statute or otherwise in law or in equity, if any, including, but not limited to, implied warranties and conditions of merchantability or merchantable quality, fitness for a particular purpose, durability, or those arising by a course of dealing or usage of trade, are disclaimed to the fullest extent allowable by law, or limited in duration to the term of this New Vehicle Limited Warranty. Some Countries, and/or States do not allow limitations on implied



warranties or conditions and/or how long an implied warranty or condition lasts, so the above limitations may not be applicable to you and your vehicle.

This New Vehicle Limited Warranty or any implied warranties cover necessary repairs and parts replacement as the only remedy. Automobili Pininfarina does not authorize any person or entity to modify or to create for it any other obligations or liability in connection with this New Vehicle Limited Warranty. Only Automobili Pininfarina, in its sole discretion, can decide whether to repair or replace a part and whether to use a new, re-conditioned/remanufactured parts to facilitate the repair.

Arbitration of Disputes

Any dispute, claim or controversy between you and Automobili Pininfarina arising out of, or related to, this New Vehicle Limited Warranty is subject to binding arbitration on an individual basis in accordance with the terms of the arbitration provision in your Automobili Pininfarina Vehicle Purchase Agreement.

Your Rights Under Local Law

This New Vehicle Limited Warranty gives you specific legal rights. You may also have other rights that vary by state or province.

Change of ownership

Change of ownership does not affect warranty obligations on Automobili Pininfarina goods.

The following services/goods are not included in the vehicle warranties:

- Maintenance services (offered by Automobili Pininfarina as a separate service)
- Roadside Assistance (may be offered by Automobili Pininfarina as a separate service)
- Extended Warranty (may be offered by Automobili Pininfarina as a separate service)
- Tires (Automobili Pininfarina Service/Retail Partner should assist the customer with any tire claim to the related tire manufacturer)

Start of Warranty

The warranty period starts on the day of vehicle delivery to the final customer.

If vehicle is directly sold by Automobili Pininfarina the invoice and physical delivery date must be entered in the CRM System (Customer Relationship Management) by Automobili Pininfarina Retail team.

The proof of the start of warranty is the customer's copy of vehicle invoice. Warranty terms and conditions are officially accepted by the customer at the sign of the sales contract.

A note on Cross Deliveries:

Warranty obligations on the Automobili Pininfarina goods are not affected even if the vehicle is sold and delivered to a customer who belongs to a different country. Pre-delivery Inspection will happen at Automobili Pininfarina Manufacturing Plant.

End of Warranty

The warranty period will end at 12.00am on the last day of warranty period.

WARRANTY COVERAGE

Types of Vehicle Warranties

- 1 Vehicle Warranty: the customer is covered against material faults on the purchased Automobili Pininfarina good, according to legal requirements as specified in the Owner's Manual.
- 2 Vehicle Paintwork Warranty: a special warranty on any body paintwork damage of the sold vehicle as specified in the Owner's Manual.
- 3 Vehicle Battery Warranty: the customer is covered against the repair or replacement of any malfunctioning or defective battery as specified in the Owner's Manual.

Without prejudice to any other consumer's rights provided by law, the exclusive and sole solution available to you under this New Vehicle Limited Warranty is the repair or replacement of new or re-manufactured parts by Automobili Pininfarina for the covered defects that may arise.

Automobili Pininfarina will perform repair or parts replacement – except for the exclusions and limitation described in this New Vehicle Limited Warranty – no incurring any costs to you, only when Automobili Pininfarina is notified of the covered defect within the warranty period.

New parts, reconditioned, or re-manufactured parts can be used for the repairs, at the sole discretion of Automobili Pininfarina. All replaced parts or other components become exclusive property of Automobili Pininfarina unless otherwise provided under applicable local law.



Basic Vehicle Limited Warranty

Subject to separate coverage for certain parts and vehicle systems, the exclusions and limitations described in this New Vehicle Limited Warranty, the Basic Vehicle Limited Warranty covers the repair(s) or replacement parts necessary to correct defects in the materials or workmanship of any parts manufactured or supplied by Automobili Pininfarina that occur under normal use for a period of 3 years or 100,000 km (60,000 miles), whichever comes first.

Supplemental Restraint System Limited Warranty

Contingent to the exclusions and limitations described in this New Vehicle Limited Warranty, the SRS Limited Warranty covers the repair or replacement necessary to correct defects in the materials or workmanship of the vehicle's airbag system and seat belt manufactured or supplied by Automobili Pininfarina that occur under normal use for a period of 3 years or 100,000 km (60,000 miles), whichever comes first.

High Voltage (HV) Battery and Powertrain Limited Warranty

In case the High Voltage Battery or e-axle(s) requires warranty service, Automobili Pininfarina will repair the unit or replace it with a factory reconditioned or remanufactured unit. When replacing a High Voltage Battery, Automobili Pininfarina will guarantee that the replacement battery is of similar amp hour capacity or better, than of the original battery which is being replaced. Additionally, the auxiliary batteries which are used to start the vehicle are included part of this HV Battery and Powertrain Limited Warranty.

Your vehicle's High Voltage Battery and e-axle(s) are covered under this Battery and Powertrain Limited Warranty for a period of 3 years or 100,000 km (60,000 miles), whichever comes first, with minimum 80% retention of Battery capacity over the warranty period.

If a warranty repair requires replacement of the High Voltage Battery. It- the High Voltage Battery may be replaced with a new, reconditioned, or remanufactured part at the sole and only discretion of Automobili Pininfarina. High Voltage Battery may not restore the vehicle to a “like new” state, however the amp hour capacity of the replacement High Voltage Battery will be at least equivalent to that of the installed High Voltage Battery before the failure occurred, furthermore considering the factors such as age and mileage of the vehicle. Regarding warranty claims made specific to High Voltage Battery capacity, range, or energy loss, the replacement High Voltage Battery will be able to perform and exceed the minimum specified amp hour capacity for the remainder – time or mileage of the vehicle’s original High Voltage Battery Warranty.

i *NOTE Using your vehicle's range estimates is an insufficient calculation of High Voltage Battery amp hour capacity because can be influenced by additional factors. The verification methods used to calculate High Voltage Battery amp hour capacity, and the decision of whether to provide any repairs, are at the sole discretion of Automobili Pininfarina. Despite the breadth of this warranty, some damages are not covered under this Battery and Powertrain Limited Warranty, such as damage resulting from intentional actions (including intentionally abusing or destroying your vehicle or ignoring active vehicle warnings or service notifications), a collision or accident (excluding from Battery fires as specified above), or the servicing or opening of the Battery or e-axle(s) by non-Automobili Pininfarina authorized personnel.*

Additionally, the e-axle(s) is subject to the exclusions and limitations described in this New Vehicle Limited Warranty. Damage to the High Voltage Battery resulting from the following schemes is also not covered under this Battery and Powertrain Limited Warranty:

- Damaging the High Voltage Battery, or purposely seeking out to extend (in ways other than those described in the Owner’s Manual – Battery Care/Information) or else decrease the life of the High Voltage Battery, either by physical means, programming, or other methods.
- Exposing the High Voltage Battery to direct flame (excluding from Battery fires).
- Immersing or submerging the Battery.

The Battery will experience capacity loss or degradation with time and use (which includes charging cycles)- this is normal. Loss of Battery capacity or degradation over time or due to or resulting Battery usage, is not covered under this Vehicle Battery warranty. Important information on how to maximize the capacity of the Battery is described in the Owner's Manual.

Vehicle paintwork warranty

The customer is covered against any body paintwork damage of the sold vehicle. "Exclusions and Limitations" previously stated in this document applies.

It is the owner's responsibility to ensure that the paintwork on the vehicle body is maintained by regular cleaning as prescribed in the Owner's Manual.

Tire limited warranty

The warrantor of the tires supplied as original equipment on your Battista vehicle is the tire manufacturer or tire distributor of your specific tires. **Automobili Pininfarina is NOT the warrantor of your original equipment tires.**

Please refer to the tire manufacturer's website or documentation for the warranty statement for the specific tires supplied as original equipment on your vehicle. Please contact the appropriate warrantor to obtain information on tire warranties and tire dealer service locations or for customer service.

To obtain warranty service, you must present the unserviceable tire to an authorized dealer or to an authorized dealer of the warrantor. Your Automobili Pininfarina Service Partner will also assist you with your tire service requirements or in obtaining tire warranty service from the tire manufacturer.

EXCLUSIONS AND LIMITATIONS

Warranty obligations do not exist if the fault or damage is caused by one or more of the following facts:

- The customer failed to report the fault or, despite being requested, did not promptly provide Automobili Pininfarina Service Partner with the opportunity of carrying out the remedial measure on the defect.
- A major damage occurred in consequence of the negligence of the customer of not fixing nor reporting the manufacturing defect.
- Vehicle has been improperly treated or overused (e.g., in non-authorized motorsport competitions).
- Vehicle has been used and combined in a different way not intended to happen during the production of the vehicle.

- Non-genuine, including non-quality-equivalent parts that do not meet the vehicle production specifications and/or standards.
- The customer failed to observe the Automobili Pininfarina official recommendations for the usage, servicing, and maintenance of the Automobili Pininfarina goods.
- The damage is due to acts of war, riots, earthquakes, or force majeure (Act of God).
- The Automobili Pininfarina good does not meet the specific requirements of the country where the good is used.
- The damage is indirect and outside Automobili Pininfarina responsibility, such as loss of value over time.
- The damage is due to the inobservance of the storage and transport standards by Automobili Pininfarina Service/Retail Partners.
- The damage is due to normal wear and tear, driving habits or operating conditions.
- The damage is found on items for which the customer did not pay or shared any cost.
- Mutilation is found on vehicle's hardware or software, and association to any loss or harm to any personal information/data uploaded to the vehicle resulting from any unapproved modifications or unauthorized accesstovehicledata or software from any source, including, but not limited to, non-Automobili Pininfarina parts or accessories, modifications, interfaces, viruses third party applications, trojans, bugs, malware, or any other form of interference or cyber-attack.

Warranty eligibility can be lost if:

- The damage is found on or due to unauthorized modifications/tuning on vehicle parts, components, or accessories.
- The damage is due to an Over-the-Air (OTA) update, correctly downloaded by the vehicle, but not accepted to install by the customer.

Automobili Pininfarina will evaluate the case and decide how severe the warranty coverage loss has to be, depending on the impact of the damage causes.

Automobili Pininfarina does not require you to perform all service or repairs at an Automobili Pininfarina Service Partners or Automobili Pininfarina authorized repair facility, this New Vehicle Limited Warranty may be voided, or coverage may be rejected due to improper or not following the maintenance intervals, service, or repairs.



Automobili Pininfarina Service Partners and Automobili Pininfarina authorized repair facilities maintain the necessary expertise to provide you with peace of mind knowing that your vehicle is in great hands. These facilities ensure that its staff has factory-backed training, years of expertise, tools and only Original Parts for your vehicle.

Automobili Pininfarina strongly recommends that all maintenance, service, and repairs be done at an Automobili Pininfarina Service Partners or Automobili Pininfarina authorized repair facility to avoid nullifying, or having coverage excluded from this New Vehicle Limited Warranty.

Subsequent will also void this New Vehicle Limited Warranty:

- 1 Vehicles that have had their VIN sticker or plaque impaired, damaged.

- 2 Odometer or other related mileage-keeping system disconnected, tampered, or modified so that it is difficult to determine its true indicated distance travelled.
- 3 Vehicles that bear being labelled, designated, or branded as dismantled, fire-damaged, flood-damaged, junk, rebuilt, salvaged, reconstructed, irreparable, certificate of destruction or a total loss.
- 4 Vehicles that have been determined to be a total loss by an insurance company.

Vehicle changes

Modifications or alterations to the vehicle could seriously compromise its safety and its capability to hold the road and can therefore cause accidents, with even fatal risks, and could violate the road rules of the country in which it is driven.

Any damage or problems that may arise following the modification of the car may not be covered or invalidate the official Automobili Pininfarina warranty.

If, after purchasing the car, you wish to install accessory electrical equipment, we recommend that you contact an official Automobili Pininfarina Service Partner.

Wear and tear items

All the parts of the vehicle are subject to normal wear and tear, and for this reason Automobili Pininfarina prescribes regular maintenance. Items subject to wear and tear include:

- 1 Optical damage to windshield.
- 2 Wiper blades
- 3 Door and body panel gap adjustments.
- 4 Friction material such as brake pads & linings, brake discs, suspension components, etc.
- 5 Paint finish not covered by the Vehicle Paintwork Warranty

6 Trims and items of aesthetics such as steering wheel, door pads, seats, console, and trims that are subjected to wear and tear.

Replaced Parts

Replaced parts become property of Automobili Pininfarina. Tests, inspections, and analysis on replaced parts can be performed by Automobili Pininfarina at the workshop or at Automobili Pininfarina facilities.

Genuine parts and accessories warranty

Automobili Pininfarina realizes that there are numerous sources for parts and accessories in today's automotive parts aftermarket. However, genuine parts and accessories are designed and manufactured to meet the same factory fit, performance and quality specifications of your vehicle.

In line with legal regulations, the customer is covered against material or craftsmanship defects on genuine Automobili Pininfarina Parts and Accessories from the invoice date of the purchased item for duration of 24 months.

The customer has the right to claim a warranty repair for:

- A defective purchased item.
- Other vehicle components, if damaged by the defective purchased item.

"Exclusions and Limitations" stated previously in this document applies to all Automobili Pininfarina Goods: vehicles, parts, and accessories.

Damages

Automobili Pininfarina hereby disclaims any and all indirect, incidental, special and consequential damages arising out of or relating to your vehicle, including, but not limited to, transportation to and from an Automobili Pininfarina Service Partner, loss of vehicle value, loss of time, loss of income, loss of use, loss of personal or commercial property, inconvenience or aggravation, emotional distress or harm, commercial loss (including but not limited to lost profits or earnings), towing charges, bus fares, vehicle rental, service call charges, gasoline expenses, lodging expenses, damage to tow vehicle, and incidental charges such as telephone calls, facsimile transmissions, and mailing expenses. Automobili Pininfarina shall not be liable for any direct damages in an amount that exceeds the fair market value of the vehicle at the time of the claim.



The above limitations and exclusions shall apply whether your claim is in contract, tort (including negligence and gross negligence), breach of warranty or condition, misrepresentation (whether negligent or otherwise) or otherwise at law or in equity, even if Automobili Pininfarina is advised of the possibility of such damages or such damages are reasonably foreseeable. In jurisdictions that do not allow the exclusion or limitation of indirect, direct, special, incidental, or consequential damages, the above limitations or exclusions may not apply to you.

OBTAINING WARRANTY SERVICE

To obtain warranty service, you must inform or alert an Automobili Pininfarina Service Partner within the applicable warranty period, and deliver the vehicle, at your cost, to an Automobili Pininfarina Service Partner of your choice. Please note that if the conditions warrant- costs of transportation may be covered by vehicles Limited Warranty. The location of the nearest Automobili Pininfarina Service Partner may be obtained by visiting www.automobili-pininfarina.com. The location of Automobili Pininfarina Service Partners is subject to change at any given time without notice. The most updated list of Service Partners is and will remain published at www.automobili-pininfarina.com.

When you contact your Automobili Pininfarina Service Partner, please be prepared to provide the Vehicle Identification Number (VIN), current mileage, a description of the defect, and, if possible, date and time of the occurrence.

Payment of Tax for Repairs

Some jurisdictions and/or local governments may require that tax be collected on warranty repairs. Where applicable law allows, you are responsible for payment of these taxes; Automobili Pininfarina is not responsible for these taxes.

Reasonable Time for Repairs

Please allow your Automobili Pininfarina Service Partner a reasonable time for completion of diagnosis, repairs and/or service, as estimated and communicated to you by an Automobili Pininfarina Service Partner. In certain cases, Automobili Pininfarina may require a special Field Technical Specialist/Flying Doctor to travel to your Automobili Pininfarina Service Partner in order to aid in diagnosis and/or repairs; due to this Automobili Pininfarina is not responsible for any delays due to travel delays which may prolong the repair process.

Modifications and Waivers

No entity or person, including, but not limited to, an Automobili Pininfarina employee or authorized representative, can modify or waive any part of this New Vehicle Limited Warranty. Automobili Pininfarina may occasionally offer to pay a portion or all the cost of certain repairs that are no longer covered by this New Vehicle Limited Warranty, which some states may refer to as "Good-Will Assistance". Automobili Pininfarina reserves the right to do the above and to make changes to vehicles manufactured or sold by Automobili Pininfarina and the applicable warranties, at any time, without incurring any obligation to make the same or similar payment or changes for vehicles Automobili Pininfarina previously manufactured or sold, or applicable warranties including this New Vehicle Limited Warranty. Nothing herein shall imply that any Automobili Pininfarina vehicle is free of defects.

CONSUMER LAW AND NATIONAL REGULATIONS

Automobili Pininfarina warranties do not affect customers' legal rights under the vehicle purchase agreement with Automobili Pininfarina, its Retail Partners and representatives within national jurisdictions. Local legislation governing the sale of consumer goods is indeed applicable.

In the event any warranty disputes, differences or controversies arise between the customer and Automobili Pininfarina, the latter will explore all possibilities for an amicable settlement. In case an amicable settlement is not reached, the interested parties shall submit any such dispute, difference, or controversy to the appropriate venue of national jurisdiction.

WARRANTY ENFORCEMENT LAWS AND DISPUTE RESOLUTION



In the U.S., the Magnuson-Moss Warranty Act is the federal law which governs this New Vehicle Limited Warranty. Many states and jurisdictions have laws, commonly called “Lemon Laws,” that provide you with certain rights if you have problems with your new vehicle. These laws differ depending on the state, province, or territory. Your new vehicle and its safety systems comply with applicable provincial and territorial motor vehicle laws and regulations.

To the fullest extent allowed by the law of your jurisdiction, Automobili Pininfarina requires that you first provide Automobili

Pininfarina, during the applicable warranty period specified in this New Vehicle Limited Warranty, with written notification of any defects you have experienced within a reasonable time to allow Automobili Pininfarina an opportunity to make any needed repairs before you pursue any remedy under these laws. Please send your written notification to:



Vehicles registered in the U.S.: Automobili Pininfarina Please include the following information:

- Your name and contact information.
- VIN.
- Name and location of the Automobili Pininfarina Retail Partner and/or Automobili Pininfarina Service Partner nearest you.
- Current mileage.

- Description of the defect.
- History of the attempts you have made with an Automobili Pininfarina Store or an Automobili Pininfarina representative to resolve the concern, or of any repairs or services that were not performed by an Automobili Pininfarina Service Partner or Automobili Pininfarina authorized repair facility.



Dispute Resolution (Canada Only)

The description provided in the following sections summarize the dispute settlement program administered by NCDS and applies to U.S. customers only. Customers with vehicles registered in Canada will be referred by NCDS to the Canadian Motor Vehicle Arbitration Program (“CAMVAP”) and subject to CAMVAP procedures and remedies, which differ from those described in the following

section. The dispute settlement program may be changed at any time without prior notice. Contact NCDS at the below listed address or phone number for the most current information concerning the dispute settlement program.



Dispute Resolution (U.S. Only)

In the event any disputes, differences or controversies arise between you and Automobili Pininfarina related to this New Vehicle Limited Warranty, Automobili Pininfarina will explore all possibilities for an amicable settlement. In case an amicable settlement is not reached, Automobili Pininfarina offers a dispute settlement program that proceeds in two steps.

First, if you choose to do so, you may additionally submit your dispute to a settlement program through the National Center for Dispute Settlement (“NCDS”).

Second, if you do not want to submit your dispute to the NCDS, or if you are not satisfied with the outcome of the NCDS procedure findings, you agree to resolve your dispute with Automobili Pininfarina through binding arbitration or small claims court under the terms of the Agreement to Arbitrate in your Vehicle Purchase Agreement.

Optional Dispute Resolution Through the National Center for Dispute Settlement (NCDS) (U.S. Only)

In the event that an amicable settlement is not reached, Automobili Pininfarina offers an optional dispute settlement program through:

NATIONAL CENTER FOR DISPUTE SETTLEMENT (“NCDS”) P.O. BOX 526

Mt. Clemens, MI 48046
1-866-629-3204

This dispute settlement program administered by NCDS is free of charge to you and is conducted by local NCDS professionals who are trained and experienced in mediation and arbitration.

NCDS resolves disputes involving this New Vehicle Limited Warranty which arise during the applicable warranty period specified in this New Vehicle Limited Warranty. However, NCDS will not arbitrate claims involving a vehicle used primarily for commercial purposes unless the “Lemon Law” of your state covers (1) vehicles used for commercial purposes, or (2) claims that an air bag failed to deploy or deployed when it should



not have. You must file a request for arbitration with NCDS within 60 days (or 6 months in certain jurisdictions) of the expiration of the applicable warranty period, provided you sent written notice to Automobili Pininfarina, as specified above, of the alleged defect during the applicable warranty period.

To initiate arbitration, you must contact NCDS at 1-866-629-3204 or P.O. Box 526, Mt. Clemens, MI 48046, and complete an NCDS customer claim form and mail it to NCDS. Please also provide a copy of your written notification sent to Automobili Pininfarina and/or all information required in such notification specified above, your desired resolution, and all receipts if requesting reimbursement. Upon receipt of your request, NCDS will contact you regarding the status of your case and provide you with additional details about the program.

NCDS may only resolve disputes between you and Automobili

Pininfarina on an individual basis. In other words, you may initiate an arbitration against Automobili Pininfarina through NCDS only in your individual capacity and not as a plaintiff or class member in any class or representative action.

When NCDS receives your request, it will be forwarded to Automobili Pininfarina for a response. After analyzing all information pertaining to your case, NCDS will schedule a technical evaluation if applicable. If you request it, an oral hearing will be held prior to a decision being rendered. At this hearing, all evidence is admissible. After considering all testimony and documents, the arbitrator will review the applicable legal standards and render a decision. A settlement satisfactory to all parties may be negotiated at any time, including prior to or after the arbitrator's decision.

NCDS's decision is binding on Automobili Pininfarina but not on you. If you accept NCDS's decision, Automobili Pininfarina

will comply with the decision in a reasonable time not to exceed 30 days after Automobili Pininfarina receives notice of your acceptance. Remedies include but are not limited to repairs; reimbursement for repairs and incidental expenses, such as transport costs; and repurchase or replacement of your vehicle. NCDS decisions do not include attorney fees or punitive, multiple, or consequential damages, except incidental damages as required by applicable law.

If you are not satisfied with the arbitrator's decision or Automobili Pininfarina's compliance, you may pursue your claim in binding arbitration on an individual basis in accordance with the arbitration provision in your Automobili Pininfarina Vehicle Purchase Agreement.

Agreement to Binding Arbitration (U.S. Only)

All disputes not resolved by NCDS will be arbitrated under the terms of the Agreement to Arbitrate in your Vehicle Purchase Agreement. Under that Agreement, you agreed to resolve disputes with Automobili Pininfarina by arbitration rather than by litigation in court. Please see the Vehicle Purchase Agreement for more details. If you prefer not to submit your dispute to NCDS, you may proceed directly to binding arbitration or small claims court under the terms of the Vehicle Purchase Agreement.



ROADSIDE ASSISTANCE

Roadside Assistance

In case of emergency, contact your nearest Automobili Pininfarina Service Partner.

Contact details can be found on Essenza App or Automobili Pininfarina website.

The Automobili Pininfarina Service Partner or assigned Roadside Assistance operator will provide you with necessary assistance.

Towing for recovery

Your Automobili Pininfarina Battista is equipped with a front towing eye mounting only.

⚠️ *Do not attempt to tow the vehicle on its wheels, doing so could damage the gearboxes. The towing eye must only be used to winch the vehicle onto a trailer or transporter for recovery purposes. Do not use a rigid bar to tow the vehicle.*



Recovery of Battista must be done only by means of a flatbed recovery vehicle or alternatively a vehicle trailer. No other means of transport is permitted.

Towing eye and mounting

- 1 Remove the cover from the towing eye mounting in the front bumper.



- 2 Screw the towing eye clockwise into the mounting hole, ensuring that it is screwed into the full extent of the thread.
- 3 If the vehicle can be powered on, attempt to use the vehicle suspension lift system to allow for greater ground clearance to winch the vehicle onto the flatbed.

- 4 Place the vehicle in Neutral by selecting the gear using the gear selector knob (refer to “Gear selector Knob” section in “Starting and driving” chapter).

i *NOTE To avoid damage to the towing eye and the vehicle, it is important to ensure that the towing eye is in full contact with the mating surface of the front structure*

i *NOTE A winch cable/strap must be secured to the towing eye only or the vehicle could be damaged. Vehicle can only be pulled straight forward using the hook, otherwise damage may occur.*

- 5 Remove the towing eye, stow it in the luggage compartment and refit the cover to the towing eye mounting as soon as the vehicle has been recovered.

Air Shipping

⚠ *Prior to transporting your Battista by means of Air Cargo, please contact Automobili Pininfarina for further instructions.*

Disclaimers

Redmi is a registered trademark of Xiaomi Inc.

Samsung Galaxy is a registered trademark of Samsung Electronics Co., Ltd.

iPhone is a registered trademark of Apple Inc.

Samsung is a registered trademark of Samsung Electronics Co., Ltd.

Pixel 3 is a registered trademark of Google LLC.

Naim is a registered trademark of Naim Audio Ltd.

HTC Desire Pro is a registered trademark of HTC Corporation.



INDEX

NUMERI

12V power supply.....148

A

ACOUSTIC NOTIFICATIONS.....62

Seat belt warning light.....63

ACOUSTIC VEHICLE ALERTING
SYSTEM (AVAS).....39

AIR BAGS.....27

Front airbags.....28

Passenger side front airbag.....28

Side Bags.....31

AIR DIFFUSER.....86

Adjustable Side / central air diffusers.....86

AMBIENT LIGHTING.....94

AUDIO.....50

AUTOMATIC VEHICLE HOLD (AVH) .121

AUTOMOBILI PININFARINA
APPROVED TIRES.....174

B

BASIC SERVICING PROCEDURES....159

Checking brake fluid.....160

Checking the battery coolant.....160

Cleaning/replacing wiper blades.....159

Topping up windshield washer fluid.....161

BATTERY.....173

BATTERY CARE / INFORMATION.....140

BONNET.....79

BRAKES.....123, 172

Brake discs and pads.....124

Brake temperature monitoring.....124

C

CAR INACTIVITY (LONG TERM
STORAGE).....166

CENTRAL DISPLAY.....44

CHARGING.....137

CHARGING INSTRUCTION.....141

Charge port emergency opening.....144

Charge port indication (E-Heart).....143

Charging setting / information on
display.....144

Charging status.....145

Starting to charge.....141

CHARGING SOCKET UNLOCK
TOOL.....150

For European version.....150

For US version.....151

CHILD PASSENGERS.....33

CLIMATE CONTROLS.....55

CONFORMITY DECLARATION
FOR FREQUENCY.....177

CONNECTING TO WI-FI.....51

CONNECTIVITY.....41

CONSUMER LAW AND
NATIONAL REGULATIONS.....191

CONTROLS AND SETTINGS.....67

CONTROLS ON DASHBOARD.....85

CREEP MODE.....121

CRUISE CONTROL.....126

Activation / Deactivation.....127

Setting the desired speed.....128

D

DASHBOARD.....21

DIMENSIONS.....176

DISPLAYS.....42

DOOR MIRRORS..... 88
 Heated Mirrors..... 89

DOORS 72
 Accessing the luggage compartment.....74
 Doors opening.....73
 Locking/unlocking doors from the
 inside.....72
 Locking/unlocking doors from the
 outside.....72
 Lock/unlock car assistant on display.....75
 Passive entry.....75

DRIVE MODE KNOB.....108

DRIVE MODE SETTINGS.....108
 Calma.....110
 Carattere.....112
 Energica.....110
 Energy recuperation.....113
 Furiosa.....111
 Launch Mode.....111
 Pura.....110
 Stability controls.....115
 Steering feel.....114
 Suspension.....114
 Torque vectoring.....115

Driving safety system.....118

DRIVING SAFETY SYSTEM.....116
 ABS (Anti-lock Braking System).....118
 Deactivating stability controls
 (ESC & TCS).....119
 Electronic stability control (ESC).....119
 Stability controls dynamic modes.....120
 Traction control system (TCS).....119

E

Easy entry.....82

EASY ENTRY.....82

ELECTRIC VEHICLE COMPONENTS138

ELECTRIC VEHICLE OVERVIEW15

ELECTRIC VEHICLE SAFE-
 GUARD SYSTEM36
 Emergency First Responders
 Safety Loop.....36
 High Voltage Interlock Loop (HVIL).....36
 High Voltage Service Disconnect
 Switch (HV SDS).....37
 Pyrotechnic HV (High-Voltage) Fuse.....36

ELECTRIC WINDOWS.....96
 Window anti-pinch safety device.....96
 Window closing.....96
 Window opening.....96

EVENT DATA RECORDERS.....35

EXCLUSIONS AND LIMITATIONS.....186
 Damages.....189
 Genuine parts and accessories
 warranty.....189
 Replaced Parts.....189
 Vehicle changes.....188
 Warranty eligibility can be lost if:.....187
 Wear and tear items.....188

EXTERNAL LIGHTS.....89
 Fog light.....93
 Headlights adjustment.....93
 Low beam lights.....92
 Reverse lights.....92
 STOP lights.....92
 Welcome and position lights /
 number plate lights.....92

F

FLAT OR PUNCTURE OF TIRE151
 Checking and restoring tire pressure....153
 Repair procedure.....153
 Tire repair kit.....152

FLUIDS AND LUBRICANTS.....177

FRONT VIEW.....19

G

GEARBOXES.....172

GEAR SELECTION.....106

D (Drive).....	107
Gear Selector Dial.....	107
N (Neutral).....	107
P (Park).....	107
Reverse (R).....	107
GEAR SELECTOR KNOB	104
GENERAL INFORMATION	103
Ground clearance.....	103
Track driving.....	103
GENERAL SETTINGS	45
GENERAL WARRANTY PROVISIONS	181
Arbitration of Disputes.....	182
Change of ownership.....	182
End of Warranty.....	183
Limitations and Disclaimers.....	181
Start of Warranty.....	183
Warranty responsible.....	181
Your Rights Under Local Law.....	182
GETTING MAXIMUM RANGE	133
To achieve maximum range:.....	133
G-FORCE METER / PERFORMANCE OVERVIEW / TRIP PERFORMANCE	125
G-Force meter.....	126
Performance overview.....	126
Trip performance.....	125

H

HAZARD WARNING LIGHTS.....	147
----------------------------	-----

I

IDENTIFICATION DATA.....	169
Manufacturer label.....	169
Tires label.....	170
Vehicle emission control information label (VECI).....	171
Vehicle identification number (vin).....	169
ILLUSTRATED TABLE OF CONTEXT....	19

IMPORTANT SAFETY INFORMATION!

IN AN EMERGENCY.....	147
----------------------	-----

INSTRUMENT PANEL.....	41
-----------------------	----

INSTRUMENT PANEL NOTIFICATION.....	62
------------------------------------	----

INTERIOR FITTINGS.....	98
------------------------	----

Ash Tray.....	98
Cigar Storage.....	99
Fire extinguisher.....	100
Glove box.....	100
USB connections.....	98

L

LEFT DISPLAY.....	43
-------------------	----

LIFT FUNCTION.....	128
--------------------	-----

LIFTING THE VEHICLE.....	147
--------------------------	-----

LIMP MODE.....	116
----------------	-----

LUGGAGE COMPARTMENT LIFTGATE.....	97
Liftgate opening in case of electrical issue.....	97

M

MAINTENANCE.....	155
------------------	-----

MEDIA JOYSTICK.....	50
---------------------	----

MEDIA SOURCES.....	47
--------------------	----

N

NATIONAL CENTER FOR DISPUTE SETTLEMENT ("NCDS") P.O. BOX 526.....	193
Agreement to Binding Arbitration (U.S. Only).....	195

NAVIGATION.....	48
-----------------	----

NEW VEHICLE LIMITED WARRANTY.....	181
-----------------------------------	-----

O			
OBTAINING WARRANTY SERVICE...190			
Modifications and Waivers.....191			
Payment of Tax for Repairs.....190			
Reasonable Time for Repairs.....191			
OVER THE AIR UPDATES (OTA) 51			
P			
PARKING THE VEHICLE.....105			
Electric parking brake106			
Emergency braking.....106			
PARK SENSORS SYSTEM129			
System activation/deactivation129			
PHONE.....52			
Deleting Bluetooth Device.....55			
In-coming calls.....54			
Main screen.....53			
Ongoing calls.....54			
Power Fold Mirrors.....88			
PRESENTATION.....13			
PRESERVING THE BODYWORK.....167			
Coated parts in real leather.....168			
Front headlights.....167			
Interior.....168			
Leather seats.....168			
	Parts in Alcantara.....168		
	Plastic parts, in carbon and coated.....168		
	Windows.....167		
	R		
	READING LIGHTS.....93		
	Dimming function.....94		
	REAR SPOILER.....122		
	REAR VIEW.....20		
	REAR VIEW MIRROR.....87		
	Brightness camera adjustment menu..87		
	Camera viewing angle		
	adjustment menu.....88		
	Interior mirror.....87		
	REMOVABLE SOFT TOP.....76		
	Washing/cleaning the soft top.....78		
	RIGHT DISPLAY.....45		
	RIMS AND TIRES.....161		
	Rims.....161		
	Tires.....162		
	Tire Usage and Maintenance.....164		
	ROADSIDE ASSISTANCE.....197		
	S		
	SAFETY.....23		
	SCHEDULED SERVICING.....155		
	SEAT BELTS.....23		
	General instructions for wearing		
	seat belts.....25		
	Pre-tensioners.....24		
	Seat belt reminder.....24		
	Seat belts maintenance.....26		
	SEATS.....80		
	Driver seat actuated adjustment.....81		
	Driver seat automatic actuated		
	adjustment.....82		
	Passenger seat actuated adjustment....82		
	Seat heating.....83		
	SILENT ALARM.....71		
	Alarm activation.....71		
	Switching on the alarm.....71		
	Turning the alarm off.....72		
	Soft-top label.....170		
	STARTING AND DRIVING.....103, 112		
	STARTING THE CAR AND DRIVING 104		
	STEERING.....173		
	STEERING WHEEL.....84		
	Adjustment.....84		
	Controls on steering wheel.....85		

SUSPENSION172

SYMBOLS.....14

T

TECHNICAL DATA.....169

THE KEYS.....67

Door Courtesy Lights 69

Driver side door emergency opening 69

Replacing the electronic key battery..... 70

Using the key.....67

Welcome light function..... 68

TIRE PRESSURE MONITORING
SYSTEM.....37

TIRE SELECTION134

TOOL KIT149

TOW MODE.....116

V

VALET MODE.....117

VEHICLE TRANSPORTATION.....168

VIEW CAMERAS131

Rear back-up camera131

Surround view camera131

W

WARNING LIGHTS AND MESSAGES.57

WARNINGS AND PRECAUTIONS.....14

WARRANTY COVERAGE.....183

Basic Vehicle Limited Warranty184

High Voltage (HV) Battery and

Powertrain Limited Warranty.....184

Supplemental Restraint System

Limited Warranty.....184

Tire limited warranty186

Types of Vehicle Warranties.....183

Vehicle paintwork warranty186

WARRANTY ENFORCEMENT
LAWS AND DISPUTE

RESOLUTION.....192

Dispute Resolution (Canada Only)192

Dispute Resolution (U.S. Only)193

WEIGHTS176

WINDSCREEN WIPER.....95

